



## Operating Instructions

### DVD Home Theater Sound System

Model No. **SC-HT680**

*Advanced progressive scan* page **6**  
Provides a smoother and sharper image.

*Compatible with a variety of media formats* page **9**  
DVD-RAM, DVD-Audio, DVD-Video and more.

*High performance sound effects* page **22**  
Sound field control (SFC), Super Surround and more.

#### Region number

The player plays DVD-Video marked with labels containing the region number "1" or "ALL".

Example:



As an ENERGY STAR® Partner,\* Panasonic has determined that this product meets the ENERGY STAR® guidelines for energy efficiency.

\* For Canada only: The word "Participant" is used in place of the word "Partner".

If you have any questions contact  
**In the U.S.A.: 1-800-211-PANA (7262)**  
**In Canada: 1-800-561-5505**

**Before connecting, operating or adjusting this product, please read the instructions completely. Please keep this manual for future reference.**

# Dear customer

Thank you for purchasing this product.  
For optimum performance and safety, please read these instructions carefully.

Operations in these instructions are described mainly with the remote control, but you can perform the operations on the main unit if the controls are the same.

System	SC-HT680
Main unit	SA-HT680
Front speakers	SB-FS680
Center speaker	SB-PC680
Surround speakers	SB-FS681
Subwoofer	SB-W680

**CAUTION!**  
THIS PRODUCT UTILIZES A LASER.  
USE OF CONTROLS OR ADJUSTMENTS OR PERFORMANCE OF PROCEDURES OTHER THAN THOSE SPECIFIED HEREIN MAY RESULT IN HAZARDOUS RADIATION EXPOSURE.  
DO NOT OPEN COVERS AND DO NOT REPAIR YOURSELF. REFER SERVICING TO QUALIFIED PERSONNEL.

**WARNING:**  
TO REDUCE THE RISK OF FIRE, ELECTRIC SHOCK OR PRODUCT DAMAGE, DO NOT EXPOSE THIS APPARATUS TO RAIN, MOISTURE, DRIPPING OR SPLASHING AND THAT NO OBJECTS FILLED WITH LIQUIDS, SUCH AS VASES, SHALL BE PLACED ON THE APPARATUS.

**CAUTION!**  
DO NOT INSTALL OR PLACE THIS UNIT IN A BOOKCASE, BUILT-IN CABINET OR IN ANOTHER CONFINED SPACE. ENSURE THE UNIT IS WELL VENTILATED. TO PREVENT RISK OF ELECTRIC SHOCK OR FIRE HAZARD DUE TO OVERHEATING, ENSURE THAT CURTAINS AND ANY OTHER MATERIALS DO NOT OBSTRUCT THE VENTILATION VENTS.

The socket outlet shall be installed near the equipment and easily accessible or the mains plug or an appliance coupler shall remain readily operable.

**THE FOLLOWING APPLIES ONLY IN THE U.S.A.**

**CAUTION:**  
This equipment has been tested and found to comply with the limits for a Class B digital device, pursuant to Part 15 of the FCC Rules.  
These limits are designed to provide reasonable protection against harmful interference in a residential installation. This equipment generates, uses and can radiate radio frequency energy and, if not installed and used in accordance with the instructions, may cause harmful interference to radio communications. However, there is no guarantee that interference will not occur in a particular installation. If this equipment does cause harmful interference to radio or television reception, which can be determined by turning the equipment off and on, the user is encouraged to try to correct the interference by one or more of the following measures:

- Reorient or relocate the receiving antenna.
- Increase the separation between the equipment and receiver.
- Connect the equipment into an outlet on a circuit different from that to which the receiver is connected.
- Consult the dealer or an experienced radio/TV technician for help.

Any unauthorized changes or modifications to this equipment would void the user's authority to operate this device.

This device complies with Part 15 of the FCC Rules. Operation is subject to the following two conditions: (1) This device may not cause harmful interference, and (2) this device must accept any interference received, including interference that may cause undesired operation.

**CAUTION**

**RISK OF ELECTRIC SHOCK  
DO NOT OPEN**

**CAUTION: TO REDUCE THE RISK OF ELECTRIC SHOCK, DO NOT REMOVE SCREWS. NO USER-SERVICEABLE PARTS INSIDE. REFER SERVICING TO QUALIFIED SERVICE PERSONNEL.**

The lightning flash with arrowhead symbol, within an equilateral triangle, is intended to alert the user to the presence of uninsulated "dangerous voltage" within the product's enclosure that may be of sufficient magnitude to constitute a risk of electric shock to persons.

The exclamation point within an equilateral triangle is intended to alert the user to the presence of important operating and maintenance (servicing) instructions in the literature accompanying the appliance.

<b>CAUTION</b>	- LASER RADIATION WHEN OPEN. DO NOT STARE INTO BEAM. FDA 21 CFR / Class II
<b>CAUTION</b>	- VISIBLE AND INVISIBLE LASER RADIATION WHEN OPEN. AVOID EXPOSURE TO BEAM. IEC60825-1 / Class 3b
<b>WARNING</b>	- SYNLIIG OCH OSYNLIIG LASERSTRÅLNING NÄR DENNA DEL ÄR ÖPPNAD. BETRÄKTA EJ STRÅLEN.
<b>ADVARSEL</b>	- SYNLIIG OG OSYNLIIG LASERSTRÅLING VED ÅBNING. UNDGÅ UDSETTELSE FOR STRÅLING.
<b>ADVARSEL</b>	- SYNLIIG OG OSYNLIIG LASERSTRÅLING NÄR DEKSEL ÅPNET. UNNGÅ EKSPONERING FÖR STRÅLEN.
<b>VARO!</b>	- AVIHTAESSA OLET ALTUINNA NÄKÄYVÄÄ JA HÄRKÄÄTÖN LASERSÄTELEVILLE. ÄLÄ KATSO SÄTELEEN.
<b>VORSICHT</b>	- SICHTBARE UND UNSICHTBARE LASERSTRAHLUNG. WENN ABECKUNG GEÖFFNET, NICHT DEM STRAHL AUSSETZEN.
<b>ATTENTION</b>	- RAYONNEMENT LASER VISIBLE ET INVISIBLE EN CAS D'OUVERTURE. EXPOSITION DANGEREUSE AU FAISCEAU.
注意	- 打开时有可见及不可见激光辐射。请勿直视光束。
注意	- こを開くと可視及び不可視レーザー光が出ます。ビームを見たり、触れたりしないで下さい。POLXS0064

(Inside of product)

# IMPORTANT SAFETY INSTRUCTIONS

Read these operating instructions carefully before using the unit. Follow the safety instructions on the unit and the applicable safety instructions listed below. Keep these operating instructions handy for future reference.

- 1) Read these instructions.
- 2) Keep these instructions.
- 3) Heed all warnings.
- 4) Follow all instructions.
- 5) Do not use this apparatus near water.
- 6) Clean only with dry cloth.
- 7) Do not block any ventilation openings. Install in accordance with the manufacturer's instructions.
- 8) Do not install near any heat sources such as radiators, heat registers, stoves, or other apparatus (including amplifiers) that produce heat.
- 9) Do not defeat the safety purpose of the polarized or grounding-type plug. A polarized plug has two blades with one wider than the other. A grounding-type plug has two blades and a third grounding prong. The wide blade or the third prong are provided for your safety. If the provided plug does not fit into your outlet, consult an electrician for replacement of the obsolete outlet.
- 10) Protect the power cord from being walked on or pinched particularly at plugs, convenience receptacles, and the point where they exit from the apparatus.
- 11) Only use attachments/accessories specified by the manufacturer.
- 12) Use only with the cart, stand, tripod, bracket, or table specified by the manufacturer, or sold with the apparatus. When a cart is used, use caution when moving the cart/apparatus combination to avoid injury from tip-over.
- 13) Unplug this apparatus during lightning storms or when unused for long periods of time.
- 14) Refer all servicing to qualified service personnel. Servicing is required when the apparatus has been damaged in any way, such as power-supply cord or plug is damaged, liquid has been spilled or objects have fallen into the apparatus, the apparatus has been exposed to rain or moisture, does not operate normally, or has been dropped.



## Table of contents

### Getting started

#### IMPORTANT SAFETY INSTRUCTIONS . . . . . 3

##### Simple setup

- STEP 1 Front speaker assembly . . . . . 4**
- STEP 2 Positioning . . . . . 5**
- STEP 3 Speaker connections . . . . . 6**
- STEP 4 Video connections . . . . . 6**
- STEP 5 Antennas and AC power supply cord . . . . . 7**  
Optional antenna connections
- STEP 6 The remote control . . . . . 7**
- STEP 7 QUICK SETUP . . . . . 8**

#### Control reference guide . . . . . 8

#### Discs that can be played . . . . . 9

#### Main unit and disc caution. . . . . 9

### Disc operations

- Basic play . . . . . 10**  
Using the main unit/Using the remote control

#### Convenient functions . . . . . 12-15

- Disc information/Displaying current playback condition (QUICK OSD)/Reviewing titles to play (ADVANCED DISC REVIEW)/
- CD sequential play (CD MODE)/Quick replay/
- Skipping one minute forward (CM SKIP)/
- Changing the zoom ratio/Changing play speed/
- Angle selection and Still picture rotation/advance/
- Changing soundtracks/Changing subtitles/
- Repeat play/Program/Random play

#### Using navigation menus . . . . . 16

- Playing data discs/
- Playing from the selected track in the CD/
- Playing HighMAT™ discs/Playing RAM discs

#### Using on-screen menus . . . . . 18

- Main menu/Other Settings

#### Changing the player settings . . . . . 20

- Changing the delay time (Speaker Settings)

### Other operations

#### Sound field and sound quality . . . . . 22

- Sound Field Control/Super Surround/Center Focus/
- Dolby Pro Logic II/Down-mixing/Subwoofer level/
- Speaker level adjustments

#### Other useful functions . . . . . 23

- Sleep timer/Muting/Using headphones

#### The radio . . . . . 24

- Automatic presetting/Manual tuning/
- Selecting the preset channels

#### Operating other equipment . . . . . 25

- Operating the television and the video cassette recorder

### Reference

#### Other speaker setup options . . . . . 26

#### Specifications . . . . . 27

#### Troubleshooting guide . . . . . 28

#### Product Service/Maintenance/Glossary . . . . . 30

#### Limited Warranty (ONLY FOR U.S.A.) . . . . . 31

#### Accessories . . . . . Back cover

# Simple setup

## STEP 1 Front speaker assembly

The supplied stands are specially designed for attachment to Panasonic SB-FS680 front speakers. Use only as indicated in this setup.

### Preparation

- To prevent damage or scratches, lay down a soft cloth and perform assembly on it.
- For assembly, use a Phillips-head screwdriver.
- Make sure you have all the indicated components before starting assembly, setup, and connection.
- There is no difference between the right and left speakers and pipes.

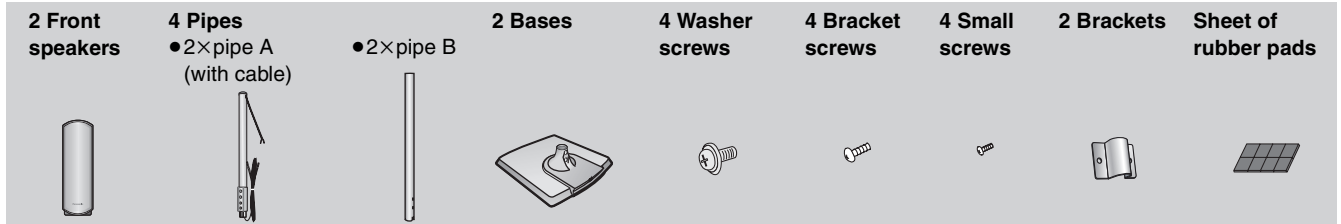

You can use the front speakers without assembling with the stands. In this case, attach the included rubber pads to the base of the speakers. This prevents vibration from causing the speakers to move or fall over. Use 3 or 4 pads per speaker.

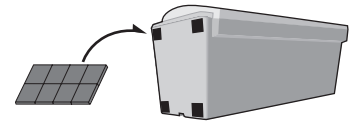

### 1 Attach the pipes to the bases.

#### 1 Insert pipe B.

Match these holes when you insert the pipe.

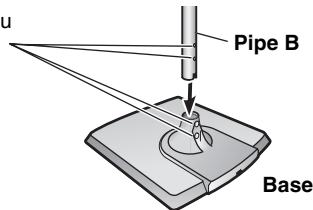

#### 2 Secure pipe B to the base.

Ensure the screws are securely fastened.

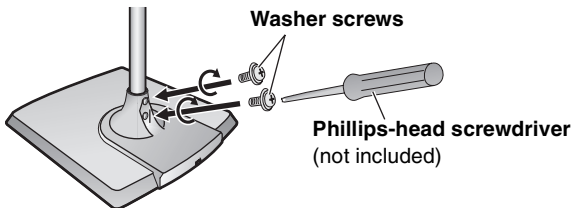

### 2 Assemble the pipes.

#### 1 Thread the speaker cable from pipe A through pipe B and the base.

For quicker threading, loosely fold the cable in half (do not crease), pass the folded portion through the pipe, and then pull the rest of the cable through the base.

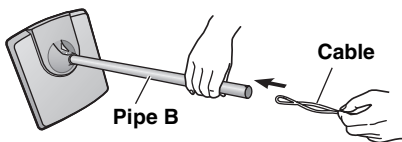

#### 2 Join pipe A to pipe B.

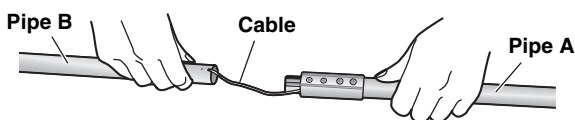

#### 3 Secure the pipes.

Ensure the screws are securely fastened.

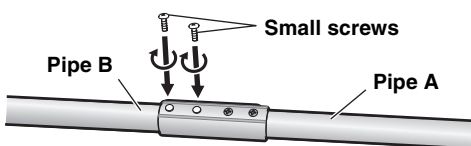

### 3 Attach the pipes to the speakers.

Slot the screw head in between the 2 stoppers of the speaker groove.

Ensure the pipe is fastened on straight by gradually tightening the right and left screws alternately until fully tightened.

To prevent a short-circuit, do not cover the connection terminals with the pipe.

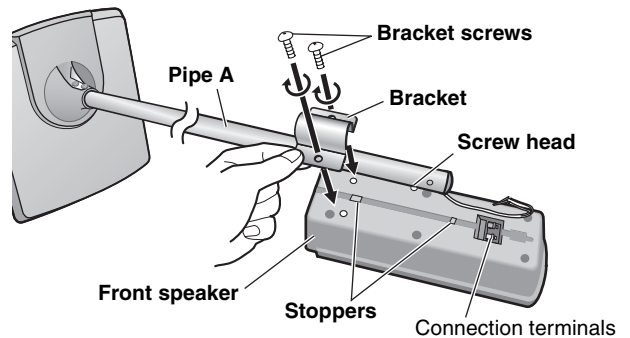

### 4 Connect the speaker cables.

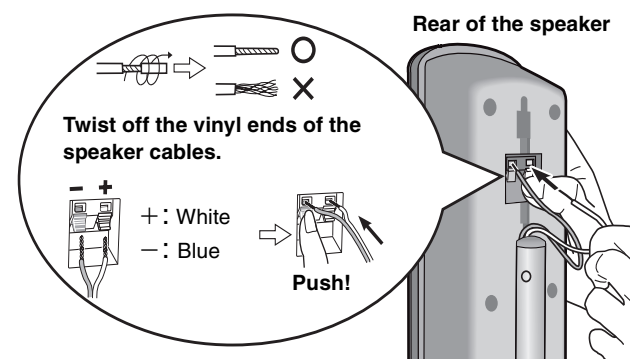

### 5 Secure the speaker cables to the bases.

1 Press the speaker cable into the base cover groove as far as possible.

2 Press the speaker cable against the base while threading it between the pegs.

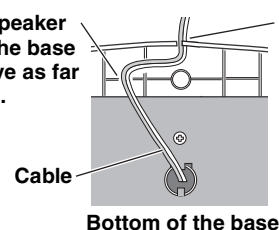

## ■ Preventing the speakers from falling over

### Preparation

Attach screw eyes (not included) to secure the speakers to the wall (→ diagram right).

- You will need to obtain the appropriate screw eyes to match the walls or pillars to which they are going to be fastened.
- Consult a qualified housing contractor concerning the appropriate procedure when attaching to a concrete wall or a surface that may not have strong enough support. Improper attachment may result in damage to the wall or speakers.

To prevent the speaker from falling over, thread the string (not included) from the wall to the speaker as shown and tie tightly.

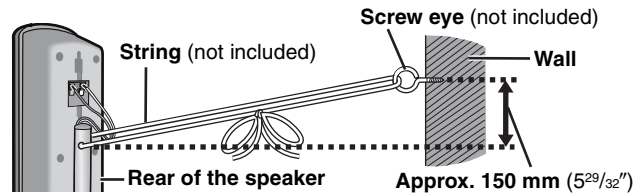

## STEP 2 Positioning

How you set up your speakers can affect the bass and the sound field. Note the following points:

- Place speakers on flat secure bases.
- Placing speakers too close to floors, walls, and corners can result in excessive bass. Cover walls and windows with thick curtains.
- The left and right speakers are the same with respect to the front and surround speaker pairs.

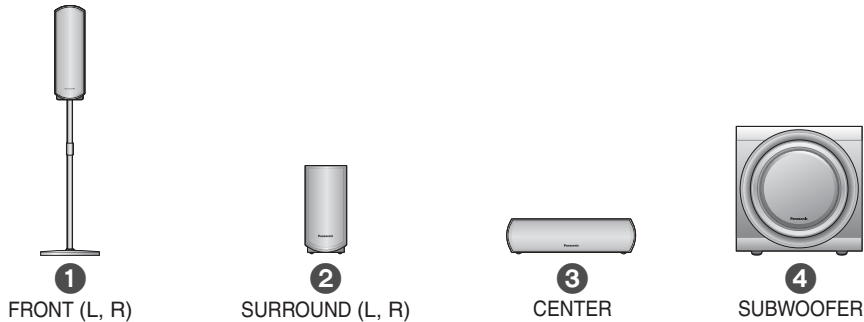

Setup example

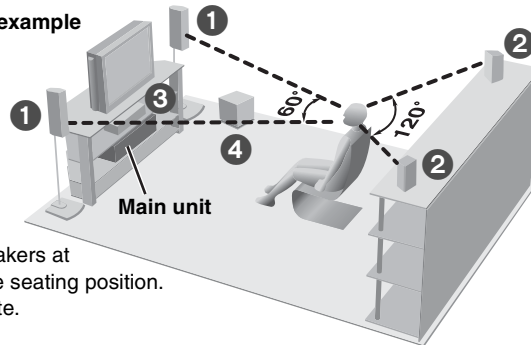

- Place the front, center, and surround speakers at approximately the same distance from the seating position. The angles in the diagram are approximate.

• Other speaker setup options (→ page 26).

### • Use only supplied speakers

Using other speakers can damage the unit, and sound quality will be negatively affected.

- Set the speakers up on an even surface to prevent them from falling. Take proper precautions to prevent the speakers from falling if you cannot set them up on an even surface.

### Main unit

#### Note

Keep your speakers at least 10 mm ( $13/32$ " ) away from the system for proper ventilation.

### Center speaker

- Vibration caused by the center speaker can disrupt the picture if it is placed directly on the television. Put the center speaker on a rack or shelf.
- To prevent the speakers from falling, do not place directly on top of the television.

### Subwoofer

Place to the right or left of the television, on the floor or a sturdy shelf so that it won't cause vibration. Leave 10 cm (4") at the rear for ventilation.

### Caution

Do not stand on the base and shake the speaker. Be cautious when children are near.

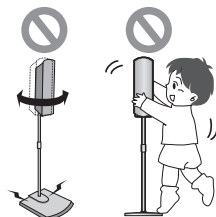

### Notes on speaker use

- You can damage your speakers and shorten their useful life if you play sound at high levels over extended periods.
- Reduce the volume in the following cases to avoid damage.
  - When playing distorted sound.
  - When the speakers are reverberating due to a record player, noise from FM broadcasts, or continuous signals from an oscillator, test disc, or electronic instrument.
  - When adjusting the sound quality.
  - When turning the unit on or off.

### If irregular coloring occurs on your television

The supplied speakers are designed to be used close to a television, but the picture may be affected with some televisions and setup combinations.

#### If this occurs, turn the television off for about 30 minutes.

The television's demagnetizing function should correct the problem. If it persists, move the speakers farther away from the television.



### Caution

- The main unit and supplied speakers are to be used only as indicated in this setup. Failure to do so may lead to damage to the amplifier and/or the speakers, and may result in the risk of fire. Consult a qualified service person if damage has occurred or if you experience a sudden change in performance.
- Do not attempt to attach these speakers to walls using methods other than those described in this manual.

# STEP 3 Speaker connections

• Attach the speaker-cable stickers to make connection easier.

## 3 Speaker cables

- 1× short cable: For center speaker
- 2× long cables: For surround speakers



## 2 Sheets of speaker-cable stickers

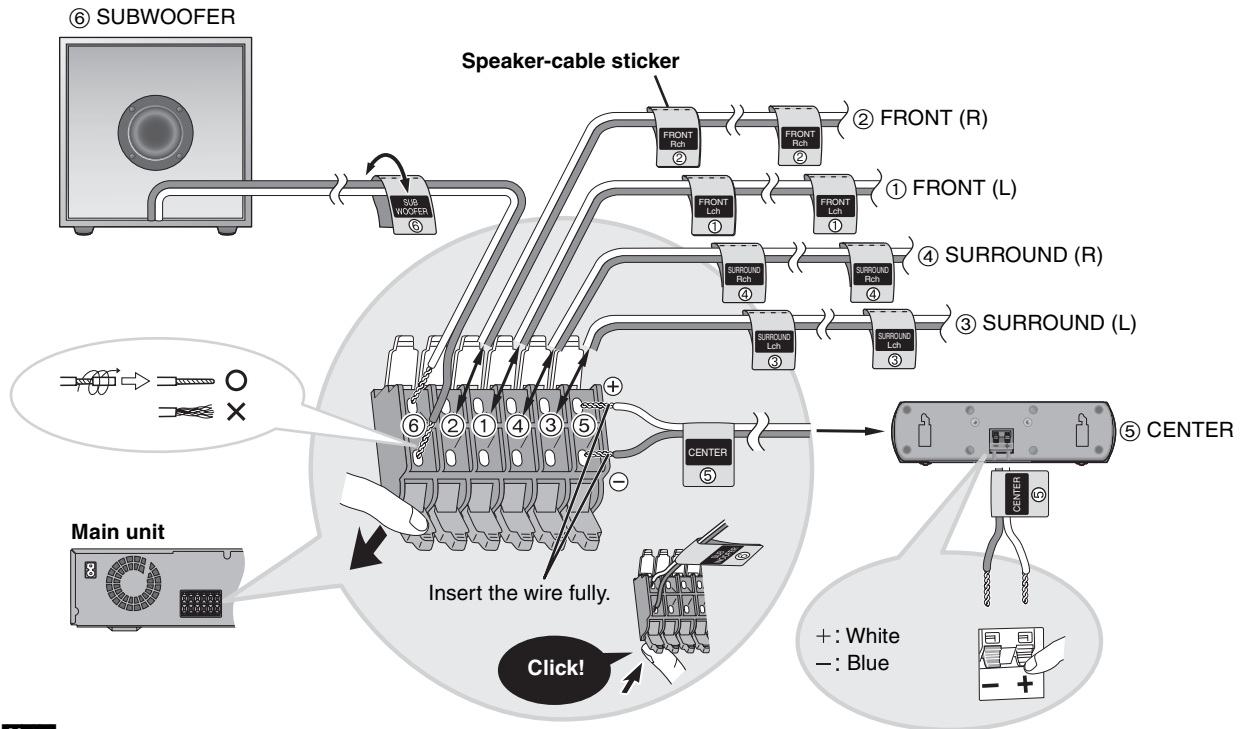

### Note

- Never short-circuit positive (+) and negative (-) speaker wires.
- Be sure to connect only positive (white) wires to positive (+) terminals and negative (blue) wires to negative (-) terminals. Incorrect connection can damage the speakers.

# STEP 4 Video connections

- Do not connect through the video cassette recorder. Due to copy guard protection, the picture may not be displayed properly.
- Turn the television off before connecting, and refer to the television's operating instructions.

## Television with a VIDEO IN terminal

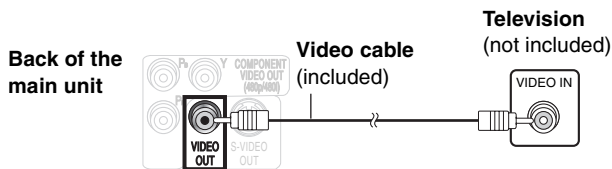

## Television with an S-VIDEO IN terminal

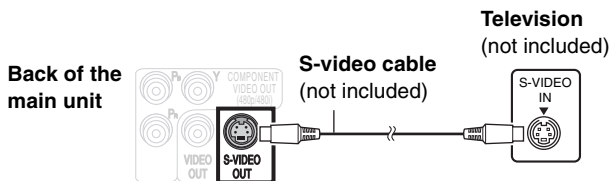

### S-VIDEO OUT terminal

The S-VIDEO OUT terminal achieves a more vivid picture than the VIDEO OUT terminal by separating the chrominance (C) and luminance (Y) signals. (Actual results depend on the television.)

### Video cable



## Television with COMPONENT VIDEO IN terminals

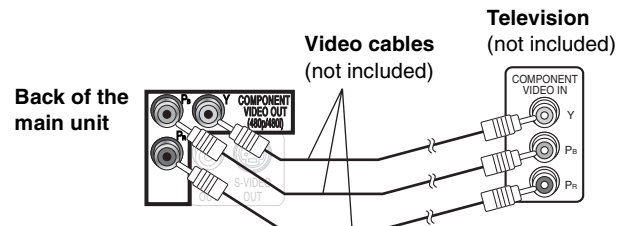

### COMPONENT VIDEO OUT terminals

These terminals can be used for either interlace or progressive output and provide a purer picture than the S-VIDEO OUT terminal. Connection using these terminals outputs the color difference signals (P<sub>B</sub>/P<sub>R</sub>) and luminance signal (Y) separately in order to achieve high fidelity in reproducing colors.

- The description of the component video input terminals depends on the television or monitor (e.g. Y/P<sub>B</sub>/P<sub>R</sub>, Y/B-Y/R-Y, Y/C<sub>B</sub>/C<sub>R</sub>). Connect to terminals of the same color.
- After making this connection, select "Darker" from the "Black Level Control" in the "Video" tab (→ page 21).

## To enjoy progressive video

- Connect to the component video input terminals on a 480p compatible television. (Video will not be displayed correctly if connected to an incompatible television.)
- All Panasonic televisions that have 480p input connectors are compatible. Consult the manufacturer if you have another brand of television.

# STEP 5 Antennas and AC power supply cord

● Connect the AC power supply cord after all other connections are complete.

## Conserving power

The main unit consumes a small amount of power (approx. 0.5 W), even when it is turned off. To save power when the unit is not to be used for a long time, unplug it from the household AC outlet.

You will need to reset some memory items after plugging in the unit.

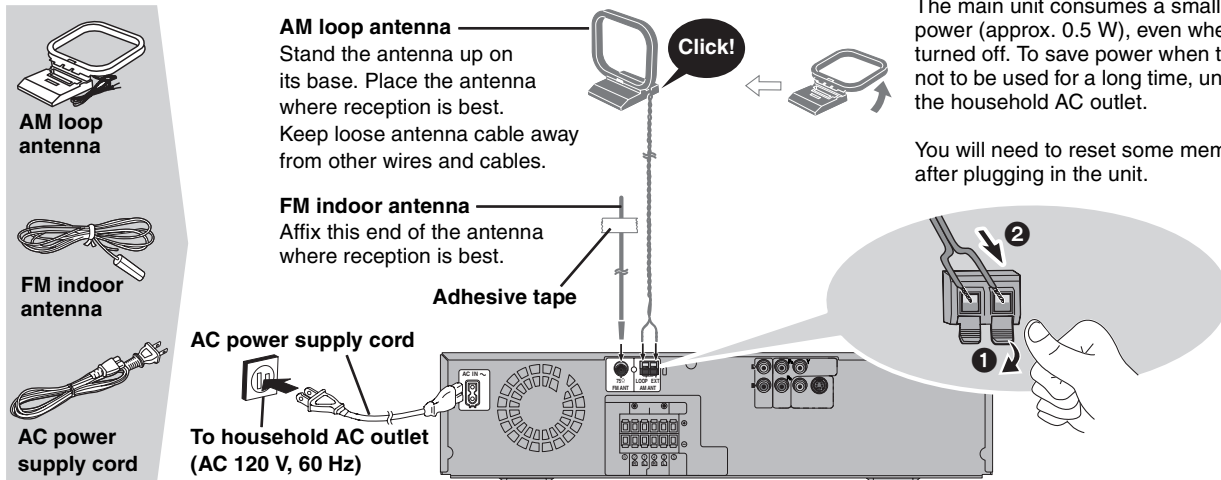

## Optional antenna connections

Use outdoor antennas if radio reception is poor.

- Disconnect the antenna when the unit is not in use.
- Do not use the outdoor antenna during an electrical storm.

### FM outdoor antenna (Using a television antenna)

- Disconnect the FM indoor antenna.
  - The antenna should be installed by a competent technician.
- Rework your outdoor antenna's 75  $\Omega$  coaxial cable as follows:

### AM outdoor antenna (Using a vinyl wire)

Run a piece of vinyl wire horizontally across a window or other convenient location.

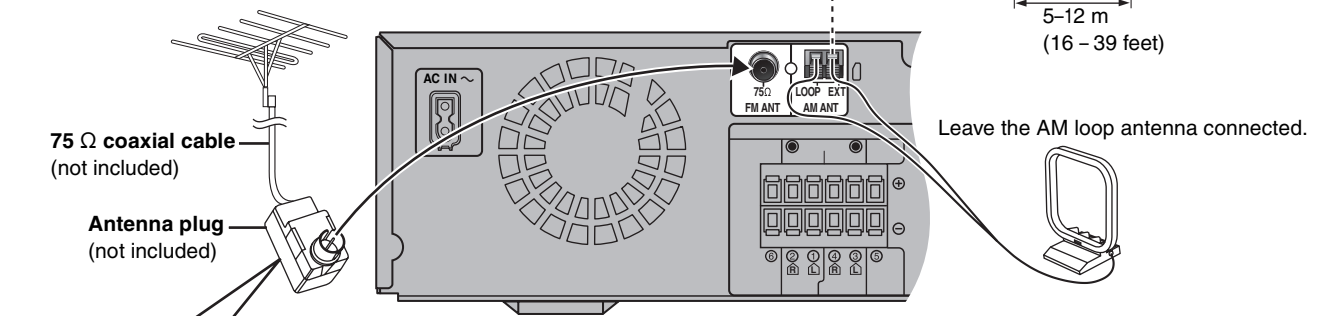

① Remove a piece of the outer vinyl insulator.

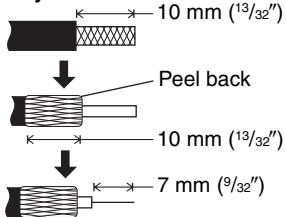

② Carefully pull the tabs apart to remove the cover.

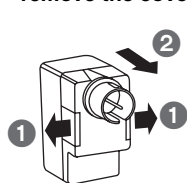

③ Install the coaxial cable. Clamp the cable conductor, and wind it on so that it does not contact anything else.

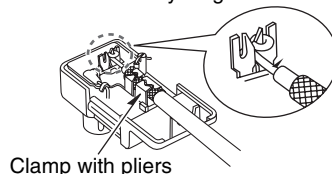

④ Attach the cover.

# STEP 6 The remote control

Remote control

Batteries

② Insert so the poles (+ and -) match those in the remote control.

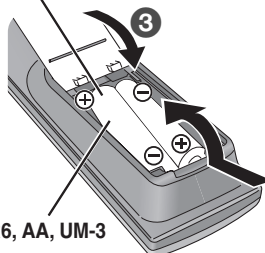

R6/LR6, AA, UM-3

- ① ● Do not use rechargeable type batteries.

## Do not:

- mix old and new batteries.
  - use different types at the same time.
  - heat or expose to flame.
  - take apart or short circuit.
  - attempt to recharge alkaline or manganese batteries.
  - use batteries if the covering has been peeled off.
- Mishandling of batteries can cause electrolyte leakage which can damage items the fluid contacts and may cause a fire.

Remove if the remote control is not going to be used for a long period of time. Store in a cool, dark place.

## Use

Aim at the display (→ page 8), avoiding obstacles, at a maximum range of 7 m (23 feet) directly in front of the unit.

# STEP 7 QUICK SETUP

The QUICK SETUP screen assists you to make necessary settings.

Turn on the television and select the appropriate video input on the television.

<b>1</b>	<b>2</b>	<b>3</b>	<b>4</b>	<b>5</b>	<b>6</b>
	DVD/CD 	SHIFT + SETUP MUTING +	Select ENTER Register 	RETURN 	ENTER 
<b>Turn on the unit.</b>	<b>Select "DVD/CD".</b>	<b>Show the QUICK SETUP screen.</b>	<b>Follow the messages and make the settings.</b>	<b>Press to finish QUICK SETUP.</b>	<b>Press to exit.</b>

To change these settings later

Select "QUICK SETUP" in the "Others" tab (→ page 21).

## Control reference guide

See reference pages in brackets.

Turn the unit on/off (8)

Select the disc or show disc information (12)  
Switch the television's video input mode. (25)

Select television channels and disc's title numbers etc./Enter numbers (11)

Cancel (11)

Basic operations for play (11)

Show a disc top menu (16) or program list (17)

Select or register menu items on the television screen, Frame-by-frame (11)

Show on-screen menu (18) or television volume down (25)

Television and Video cassette recorder operations (25)

Select the source AUX (25), TUNER/BAND (24), DVD/CD (8)

Channel select (24, 25)

Adjust the volume. (11)

Show a disc menu (16) or playlist (17)

Return to previous screen (11) or television volume up (25)

To use functions labeled in orange:  
While pressing [SHIFT], press the corresponding button.

SUBWOOFER LEVEL (22)	SUPER SRND (22)	C.FOCUS SFC (22)	MIX 2CH DPL II (22)
SLEEP QUICK OSD (12, 23)	ZOOM CM SKIP (12, 13)	SUBTITLE AUDIO (13)	SETUP MUTING (20, 23)
FL DISPLAY (11)	ANGLE/PAGE GROUP (11, 13)	REPEAT (13)	CD MODE PLAY MODE (12, 14)
	ADVANCED DISC REVIEW (12)	PLAY SPEED QUICK REPLAY (12, 13)	TEST CH SELECT (23)

**Standby/on switch [POWER, ⏻]**  
Press to switch the unit from on to standby mode or vice versa. In standby mode, the unit is still consuming a small amount of power. (10)

**AC supply indicator [AC IN]**  
This indicator lights when the unit is connected to the AC mains supply.

**Display**

**Drawer**

**▲ OPEN/CLOSE**  
Open/Close the disc drawer. (10)

**▲ DISC CHANGE**  
Change/Load a disc. (10)

**Direct select buttons/indicators**  
Select the disc tray. (10)

**DISC CHECK**  
Check the disc trays. (10)

**■/TUNE MODE**  
Stop playing. (10)/Select the tuning mode. (24)

**■/FM MODE**  
Pause. (10)/Adjust the FM reception condition. (24)

**▶/MEMORY**  
Play discs. (10)/Memorize the receiving radio stations. (24)

**VOLUME**  
Turn up/down the volume. (10)

**◀/▶/◀◀/▶▶/√ TUNING ▲**  
Skipping or slow-search play (10)/  
Select the radio stations. (24)

**PHONES**  
Connect headphones. (23)







**CD MODE**  
Play several music CD's sequentially. (12)

**PROGRESSIVE**  
Enjoy progressive video. (10)

**SELECTOR**  
Select the source: DVD/CD→FM→AM→AUX→Return to DVD/CD (24)



# Discs that can be played

Disc	Logo	Indication in these operating instructions	Remarks
DVD-RAM		<b>RAM</b>	Recorded with devices using Version 1.1 of the Video Recording Format (a unified video recording standard), such as DVD video recorders, DVD video cameras, personal computers, etc.
		<b>JPEG</b>	Recorded using the DCF (Design rule for Camera File system) standard Version 1.0. ● To play JPEG files, select "Play as Data Disc" in Other Menu (→ page 19).
DVD-Audio		<b>DVD-A</b>	—
		<b>DVD-V</b>	Some DVD-Audio discs contain DVD-Video content. To play DVD-Video content, select "Play as DVD-Video" in Other Menu (→ page 19).
DVD-Video		<b>DVD-V</b>	—
DVD-R (DVD-Video)/ DVD-RW (DVD-Video)			Discs recorded and finalized* on DVD video recorders or DVD video cameras.
+R (Video)/ +RW (Video)	—		Discs recorded and finalized* on DVD video recorders or DVD video cameras.
Video CD		<b>VCD</b>	—
SVCD			Conforming to IEC62107
CD		<b>CD</b>	This unit is compatible with HDCD, but does not support the Peak Extend function (a function which expands the dynamic range of high level signals). HDCD-encoded CD's sound better because they are encoded with 20 bits, as compared with 16 bits for all other CD's. ● During HDCD play, "HDCD" lights on the unit's display.
CD-R CD-RW	—	<b>WMA</b> <b>MP3</b> <b>JPEG</b> <b>CD</b> <b>VCD</b>	● This unit can play CD-R/RW (audio recording disc) recorded with the formats on the left. Close the sessions or finalize* the disc after recording. ● <b>HighMAT discs</b> WMA, MP3 or JPEG files only. To play without using the HighMAT function, select "Play as Data Disc" in Other Menu (→ page 19). ● <b>WMA</b> This unit does not support Multiple Bit Rate (MBR: a file that contains the same content encoded at several different bit rates).

\* A process that allows play on compatible equipment.

● It may not be possible to play the above discs in all cases due to the type of disc or condition of the recording.

## Discs that cannot be played

DVD-ROM, CD-ROM, CDV, CD-G, SACD, DivX Video Discs and Photo CD, DVD-RAM that cannot be removed from their cartridge, 2.6-GB and 5.2-GB DVD-RAM, and "Chaoji VCD" available on the market including CVD, DVCD and SVCD that do not conform to IEC62107.

## Audio format of DVD's

This unit automatically recognizes and decodes discs with these symbols.



### Note about using a DualDisc

The digital audio content side of a DualDisc does not meet the technical specifications of the Compact Disc Digital Audio (CD-DA) format so play may not be possible.

# Main unit and disc caution

## To prevent damage

- Do not touch the drawer while it is in motion.
- Do not close the drawer by hand.

## Inserting a disc correctly

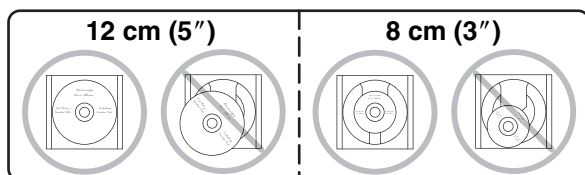

- Insert the disc correctly into position as indicated in the diagram above.
- Load only one disc per tray.
- Insert the disc with the label side facing up.

## To clean discs

Wipe with a damp cloth and then wipe dry.

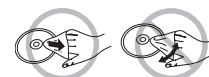

## Disc handling precautions

- Do not attach labels or stickers to discs (This may cause disc warping, rendering it unusable).
- Do not write on the label side with a ball-point pen or other writing instrument.
- Do not use record cleaning sprays, benzene, thinner, static electricity prevention liquids or any other solvent.
- Do not use scratch-proof protectors or covers.
- Do not use the following discs:
  - Discs with exposed adhesive from removed stickers or labels (rented discs, etc).
  - Discs that are badly warped or cracked.
  - Irregularly shaped discs, such as heart shapes.

# Basic play

**1** Power on. **POWER**

**2** Select "DVD/CD". **SELECTOR**

**4** Start play.

- The tray is closed automatically and play starts.
- The disc indicators show which tray is in the play position.

**When the disc finishes playing:**

If the next disc doesn't start playing, select it with the disc buttons.

- You can also select the disc using the remote control (→ page 12, Disc information).

**5** Adjust the volume.

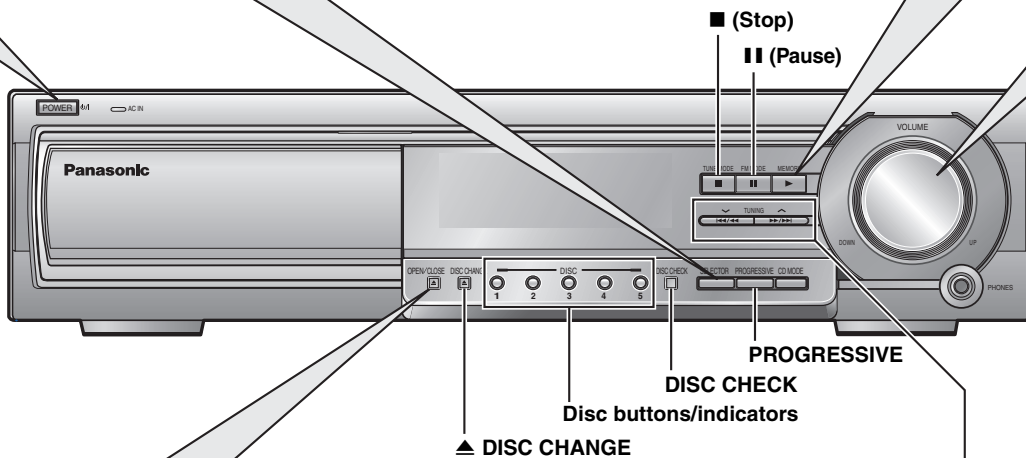

**3** Open the drawer and place the disc. **OPEN/CLOSE**

- Load double-sided discs so the label for the side you want to play is facing up.
- **RAM** Remove the disc from its cartridge before use.



**To load discs on the other trays:**

Press a disc button and then press [ OPEN/CLOSE].

- You can load up to 5 discs (one per tray).

**Do not pull or push the tray with your hand.**

**Press to skip.**

**Press and hold to**

- **search** (during play)
- **slow-motion** (during pause) (Motion picture part)

- Press [] (play) to start normal play.



## Using the main unit

**Progressive video**

**PROGRESSIVE**

**PRG**

**Checking the disc trays**

**DISC CHECK**

The disc trays are opened in a successive stack so that you can check what disc is in each tray.

- If the player is stopped, all trays will open.
- If a disc is being played, the corresponding tray will not open.

**Do not remove or insert discs during a disc check.**

- Press [DISC CHECK] again to close all trays.

**Changing the other discs without interrupting play**

**DISC CHANGE**

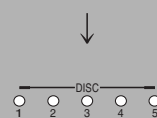

**DISC CHANGE**



The drawer remains closed until you press a disc button.

Press a disc button to open the corresponding tray.

- If you select a disc which is being played, play stops.

Exchange the disc.

Close the drawer.

- Repeat these steps to change the other discs.

**Note**

- Discs continue to rotate while menus are displayed. Press [] when you finish to preserve the unit's motor and your television screen.
- Total title number may not be displayed properly on +R/+RW.

## Using the remote control

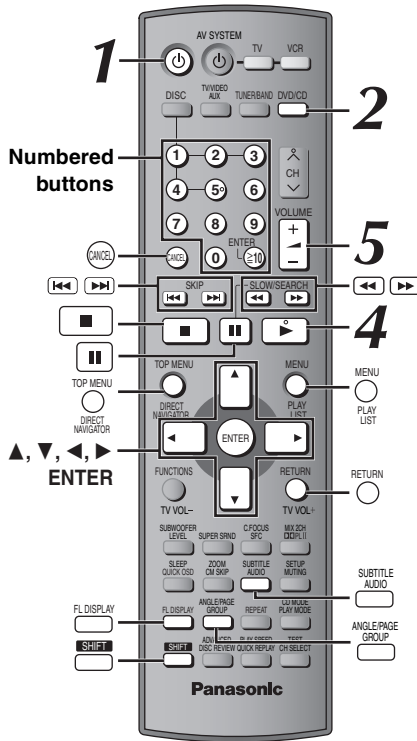

**Enter number**

RAM DVD-A DVD-V VCD CD  
e.g. To select 12:  
[≥10] → [1] → [2]

VCD with playback control  
Press [■] to cancel the PBC function, and then press the numbered buttons.

WMA MP3 JPEG  
e.g. To select 123:  
[1] → [2] → [3] → [ENTER]

● Press [CANCEL] to cancel the number(s).

**Disc menu**

TOP MENU  
Shows a disc top menu

RAM  
Shows the programs (→ page 17)

DVD-V  
Shows a disc menu

RAM  
Shows a play list (→ page 17)

VCD with playback control  
Shows a disc menu

**Stop**

The position is memorized while "RESUME" is on the display.  
● Press [▶] (play) to resume.  
● Press [■] again to clear the position.

**Pause**

● Press [▶] (play) to restart play.

**Skip**

● WMA MP3 JPEG  
[▲, ▼]: Group skip during play  
[◀, ▶]: Content skip during play

**Search (during play)**

● Up to 5 steps.  
● Press [▶] (play) to start normal play.

**Slow-motion (during pause)**

● VCD Slow-motion: forward direction only.

**Frame-by-frame (during pause)**

DVD-A (Motion picture part)  
RAM DVD-V VCD  
● VCD Forward direction only.

**On-screen item select**

Select  
Register

**Return to previous screen**

RETURN

**Main unit display**

FL DISPLAY

RAM DVD-A DVD-V VCD CD  
WMA MP3  
Time display  
↔ Information display

JPEG  
When Slideshow (→ page 18) is on:  
SLIDE ↔ Information display  
When Slideshow is off:  
PLAY ↔ Information display

**Subtitles/Information screen**

SHIFT  
+  
SUBTITLE AUDIO

RAM  
Turns subtitle on/off (→ page 13)

DVD-V VCD (SVCD only)  
Selects the subtitle languages (→ page 13)

JPEG  
Date → Details of the picture  
← No information ←

**Starting play from a selected group**

ANGLE/PAGE GROUP  
↓  
Select  
Register

DVD-A WMA MP3 JPEG  
● A folder on WMA/MP3 and JPEG discs is treated as a "Group".

# Convenient functions

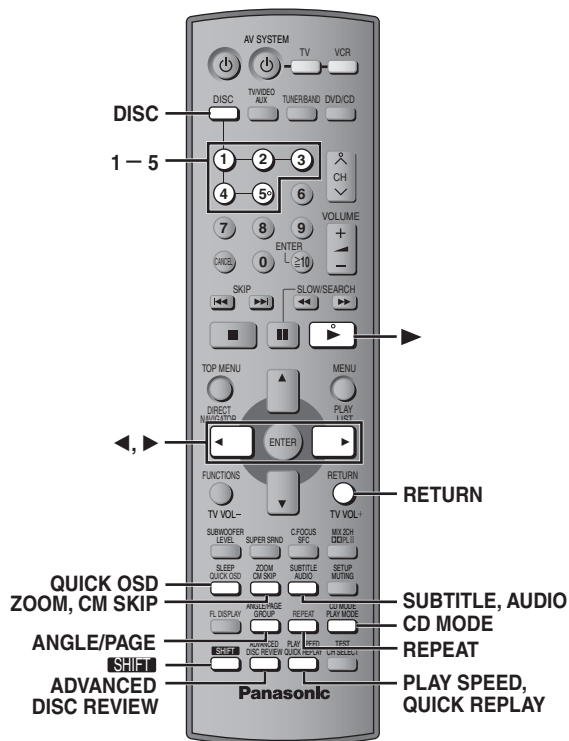

## Disc information

You can select the disc after checking the discs loaded with the Disc information screen.

- You can also select the disc directly with the disc buttons on the main unit.

### 1 Press [DISC] to show the Disc information screen.

e.g.

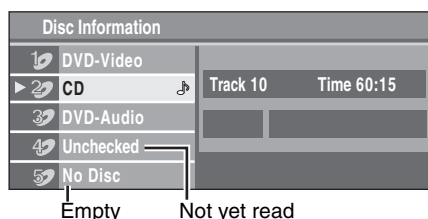

### 2 Press the numbered buttons ([1] – [5]) to select the disc.

#### To clear the screen

Press [DISC].

## Displaying current playback condition (QUICK OSD)

The current playback condition is displayed.

### Press [QUICK OSD].

e.g. **DVD-V** Current playback number Elapsed play time

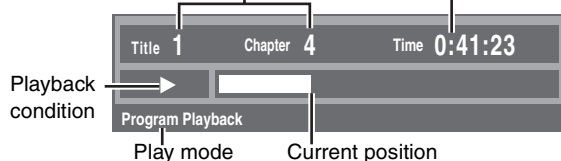

#### To exit the screen

Press [QUICK OSD].

- CD** **MP3** **WMA** The QUICK OSD screen will appear automatically.

## Reviewing titles to play (ADVANCED DISC REVIEW)

**RAM DVD-V** (Except +R/+RW)

Allows you to browse the disc contents and start playing from the selected position. You can select either "Intro Mode" or "Interval Mode" in "Advanced Disc Review" in the "Disc" tab (→ page 20).

### 1 Press [ADVANCED DISC REVIEW].

The QUICK OSD screen is displayed.

e.g. **RAM**

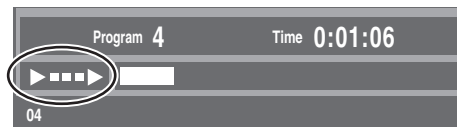

### 2 Press [▶] (play) when you find a title/program to play.

This may not work depending on the disc and the play condition.

## + CD sequential play (CD MODE)

**VCD** **CD** **WMA** **MP3**

This feature is very convenient if you want to play several music CD's sequentially. Make sure that the applicable disc is in the play position before playing (→ Disc information, left).  
DVD and JPEG are skipped without being played.

#### While stopped

### 1 Press [SHIFT]+[CD MODE].



### 2 Press [▶] (play).

#### Note

- If the disc in the play position is not applicable (e.g. DVD), CD Mode does not work and "MODE" flashes.
- HighMAT menus and Video CD playback control are disabled.
- You cannot turn CD Mode on or off during play, or while in program or random mode.
- If you want to play a DVD, press [SHIFT]+[CD MODE] again to cancel CD Mode. (CD Mode is also canceled when you open the current disc tray, select another source, or switch the unit to standby.)

## Quick replay

(Only when the elapsed play time can be displayed.)

(Except +R/+RW)

### Press [QUICK REPLAY] to skip back a few seconds.

## Skipping one minute forward (CM SKIP)

(Only when the elapsed play time can be displayed.)

**RAM DVD-V** (Except +R/+RW)

Play restarts from approximately a minute later. Convenient when you want to skip commercials etc.

### During play Press [CM SKIP].

**RAM** It is not possible to skip through the current program if the start of the next program is within about one minute of the point you are skipping from.

## Changing the zoom ratio

**DVD-A** (Motion picture part) **RAM** **DVD-V** **VCD**  
 This feature expands the letterbox picture to fit the screen.  
**During play**  
 Press **[SHIFT]+[ZOOM]** several times to select the preset aspect ratio (Just Fit Zoom) or "Auto".

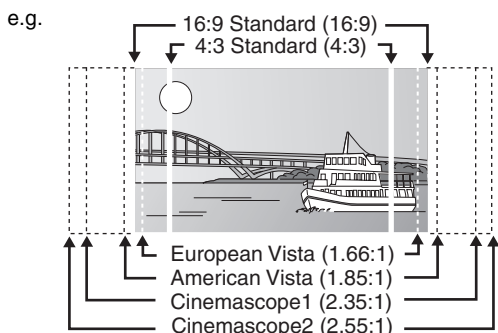
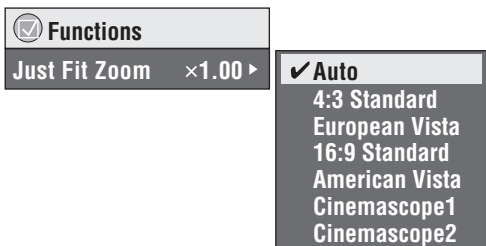

**Fine adjustments (Manual Zoom)**  
 After selecting the preset aspect ratio or "Auto", press **[◀, ▶]**.  
 –from "×1.00" to "×1.60" (in 0.01 units)  
 –from "×1.60" to "×2.00" (in 0.02 units)  
 • Press and hold **[◀, ▶]** to alter faster.

## Changing play speed

**DVD-A** (Motion picture part) **RAM** **DVD-V**  
**During play**  
 Press **[SHIFT]+[PLAY SPEED]** several times to select "Normal", "Fast" or "Slow".

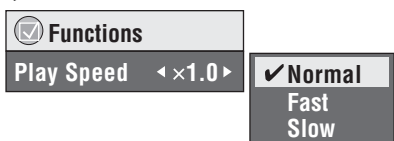

**Changing play speed between the range of "×0.6" to "×1.4" (in 0.1 units)**  
 Press **[◀, ▶]** while the above message is displayed.

- Press **[▶]** (play) to return to normal play.
- After you change the speed
  - Dolby Pro Logic II and Sound Enhancement do not work.
  - Audio output switches to 2ch.
- This function may not work depending on the disc's recording.

## Angle selection and Still picture rotation/advance

Press **[SHIFT]+[ANGLE/PAGE]** several times to select the angle or rotate/advance the still picture.

- DVD-V** (with multiple angles)–Angle selection
- JPEG** –Still picture rotation
- DVD-A** –Still picture advance  
 (Press **[RETURN]** to go back to page 1.)

## Changing soundtracks

**DVD-A** **DVD-V** (with multiple soundtracks) **RAM** **VCD**  
 Press **[AUDIO]** several times to select the soundtrack.

**RAM** **VCD**  
 You can use this button to select "L", "R" or "LR". e.g. **DVD-V**

**DVD-V** (Karaoke discs)  
 Press **[◀, ▶]** to select "On" or "Off" for vocals.  
 Read the disc's instructions for details.

**Signal type/data**  
 LPCM/PPCM/□□ Digital/DTS/MPEG: Signal type  
 kHz (Sampling frequency)/bit/ch (Number of channels)  
 Example: 3/2, 1ch

.1: Low frequency effect (not displayed if there is no signal)
0: No surround
1: Mono surround
2: Stereo surround (left/right)
1: Center
2: Front left+Front right
3: Front left+Front right+Center

## Changing subtitles

**DVD-V** (with multiple subtitles) **VCD** (SVCD only)  
 Press **[SHIFT]+[SUBTITLE]** several times to select the subtitle language.

- On +R/+RW, a subtitle number may be shown for subtitles that are not displayed.

**To display/clear the subtitles**  
 Press **[◀, ▶]** to select "On" or "Off".

**RAM** (On/Off only with discs that contain subtitle on/off information)  
 Press **[SHIFT]+[SUBTITLE]** to select "On" or "Off".

- Subtitle on/off information cannot be recorded using Panasonic DVD Recorders.

## Repeat play

(Only when the elapsed play time can be displayed.  
**JPEG**: Works with all JPEG content.)

**During play**  
 Press **[REPEAT]** several times to select an item to be repeated.

e.g. **DVD-V**

- RAM**: Program→Disc→Off
- During play list play: Scene→Playlist→Off
- DVD-A**: Track→Group\*→Off
- DVD-V**: Chapter→Title\*→Off
- VCD** **CD**: Track→Disc\*→Off
- When CD Mode is on: Track→Disc→All CD's→Off
- When CD Mode is on, during program and random play: Track→All CD's→Off
- WMA** **MP3**: Content→Group\*→Off
- When CD Mode is on: Content→Group→All CD's→Off
- When CD Mode is on, during program and random play: Content→All CD's→Off
- JPEG**: Group\*→Off

\*"All" is displayed during program and random play.



## Program/Random play

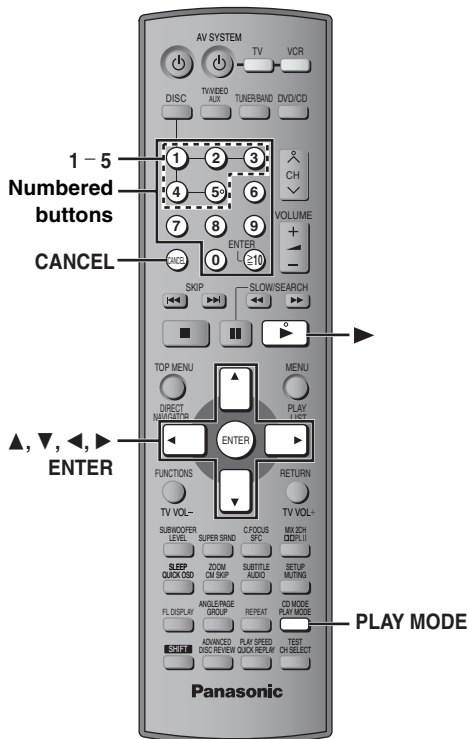

Convenient functions

### Press [PLAY MODE] while stopped.

Program and random playback screens appear sequentially.

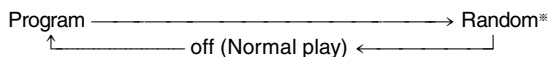

\* "ALL-DISC" (→ page 15) is displayed on the main unit's display when CD Mode is on (→ page 12).

### To exit program or random play mode

Press [PLAY MODE] several times while stopped.

- Disable HighMAT disc play to use program and random play. Select "Play as Data Disc" in Other Menu (→ page 19).
- **DVD-A**  
Some discs contain bonus groups. If a password screen appears after selecting a group, enter the password with the numbered buttons to play the bonus group. Refer also to the disc's jacket.

### Program play (up to 32 items)

#### ■ When CD Mode is off

**DVD-A DVD-V VCD CD WMA MP3 JPEG**

You can program all the items on a disc in the play position.

- 1 **DVD-A DVD-V** Press the numbered buttons to select a group (**WMA MP3 JPEG** then press [ENTER]) or title.  
e.g. **DVD-V**

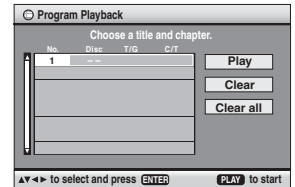

#### • To select a 2-digit number

e.g. To select 25: [≥10] → [2] → [5]

**WMA MP3 JPEG** [2] → [5] → [ENTER]

- 2 Press the numbered buttons to select a chapter or track (**WMA MP3 JPEG** then press [ENTER]).

• Repeat steps 1 and 2 to program other items.

• **VCD CD** Step 1 is unnecessary.

- 3 Press [▶] (play).

#### ■ When CD Mode is on (→ page 12)

**VCD CD WMA MP3**

You can program all the items on all the discs.

- 1 Press the numbered buttons ([1] – [5]) to select a disc.
- 2 Press the numbered buttons to select the items (**WMA MP3** then press [ENTER]).  
• To select a 2-digit number  
e.g. To select 25: [≥10] → [2] → [5]  
**WMA MP3** [2] → [5] → [ENTER]
- 3 Press [▶] (play).

#### To select an item using the cursor buttons

Press [ENTER] and [▲, ▼] to select an item, then press [ENTER] again to register.

#### To change the selected program

- 1 Press [▲, ▼] to select an item.
- 2 Repeat above steps 1 and 2.

#### To clear the selected program

- 1 Press [▲, ▼] to select an item.
- 2 Press [CANCEL] (or press [▲, ▼, ◀, ▶] to select "Clear" and press [ENTER]).

#### To clear the whole program

Select "Clear all" with [▲, ▼, ◀, ▶] and press [ENTER].

#### Note

The program is retained in memory unless one of the following occurs:

- The current disc tray is opened.
- Another source is selected.
- The unit is switched to standby.
- CD Mode is turned on or off.
- You manually select another disc (while CD Mode is off).

## Random play

### ■ When CD Mode is off

VCD CD

You can play all the items on a disc in the play position in random order.

DVD-A DVD-V WMA MP3 JPEG

You can play selected item(s) on a disc in the play position in random order.

1

DVD-A DVD-V WMA MP3 JPEG

Press the numbered buttons to select a group or a title.

e.g. DVD-V

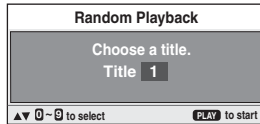

DVD-A

- To enter all groups, press [◀, ▶] to select "All" and press [ENTER].
- To deselect a group, press the numbered button corresponding to the group you want to clear.

2 Press [▶] (play).

## ALL-DISC random play

### ■ When CD Mode is on (→ page 12)

VCD CD WMA MP3

You can play all the items on all the discs in random order.

Press [▶] (play).

e.g. CD



Manufactured under license from Dolby Laboratories.

"Dolby", "Pro Logic" and the double-D symbol are trademarks of Dolby Laboratories.

"DTS" and "DTS Digital Surround" are registered trademarks of Digital Theater Systems, Inc.

Apparatus Claims of U.S. Patent Nos. 4,631,603, 4,577,216, and 4,819,098, licensed for limited viewing uses only.

This product incorporates copyright protection technology that is protected by method claims of certain U.S. patents and other intellectual property rights owned by Macrovision Corporation and other rights owners. Use of this copyright protection technology must be authorized by Macrovision Corporation, and is intended for home and other limited viewing uses only unless otherwise authorized by Macrovision Corporation. Reverse engineering or disassembly is prohibited.

MPEG Layer-3 audio decoding technology licensed from Fraunhofer IIS and Thomson multimedia.

Windows Media, and the Windows logo are trademarks, or registered trademarks of Microsoft Corporation in the United States and/or other countries.

WMA is a compression format developed by Microsoft Corporation. It achieves the same sound quality as MP3 with a file size that is smaller than that of MP3.



HighMAT™ and the HighMAT logo are either trademarks or registered trademarks of Microsoft Corporation in the United States and/or other countries.

HDCD®, HDCD®, High Definition Compatible Digital® and Pacific Microsonics™ are either registered trademarks or trademarks of Pacific Microsonics, Inc. in the United States and/or other countries.

HDCD system manufactured under license from Pacific Microsonics, Inc. This product is covered by one or more of the following: In the USA: 5,479,168, 5,638,074, 5,640,161, 5,808,574, 5,838,274, 5,854,600, 5,864,311, 5,872,531, and in Australia: 669114, with other patents pending.

# Using navigation menus

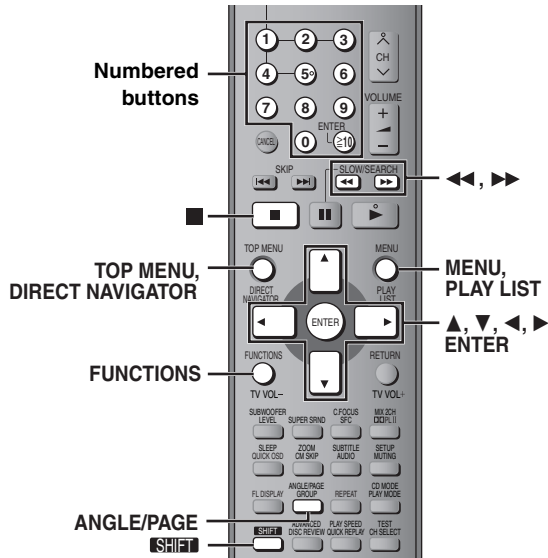

## Playing data discs

WMA MP3 JPEG

You can play JPEG files on DVD-RAM or play HighMAT discs without using the HighMAT function (→ page 19, "Play as Data Disc" in Other Menu).

- Playing HighMAT™ discs (→ page 17)

## Playing items in order (Playback Menu)

- 1 Press [TOP MENU].

e.g.

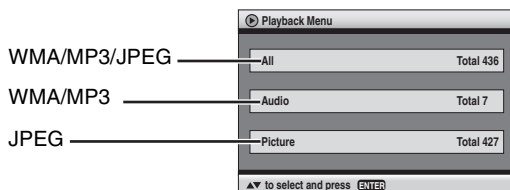

- To exit the screen  
Press [TOP MENU].

- 2 Press [▲, ▼] to select "All", "Audio" or "Picture" and press [ENTER].

## Playing from the selected item (Navigation Menu)

- 1 Press [MENU].
- 2 Press [▲, ▼, ◀, ▶] to select the group and press [ENTER].
- 3 To play content in the group in order  
Press [ENTER].  
To start play from the selected content  
Press [▲, ▼] to select and [ENTER].

e.g.

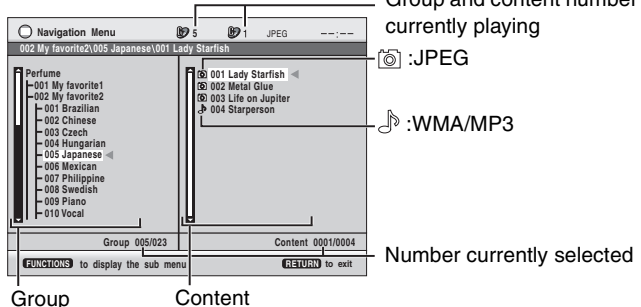

- Press [SHIFT]+[ANGLE/PAGE] to skip page by page in the group or content field.
- To enjoy listening to WMA/MP3 contents while showing a JPEG image on the screen  
Select a JPEG file first, and then select audio contents.  
(The opposite order is not effective.)
- To exit the screen  
Press [MENU].

## Using the submenu

- 1 While the menu is displayed  
Press [FUNCTIONS].
- 2 Press [▲, ▼] to select an item and press [ENTER].  
Items shown differ depending on the type of disc.

Multi	Groups and contents are displayed.
List	Contents only
Tree	Groups only
Thumbnail	Thumbnail images JPEG
Next group	To go to next group WMA MP3
Previous group	To go to previous group WMA MP3
All	WMA/MP3 and JPEG
Audio	WMA/MP3 only
Picture	JPEG only
Help display	To switch between guide messages and the elapsed play time indicator
Find	To search by content or group title (→ below)

## Searching by a content or group title

Highlight a group title to search the group, or a content title to search its content.

- 1 While the submenu is displayed (→ above)  
Press [▲, ▼] to select "Find" and press [ENTER].



- 2 Press [▲, ▼] to select a character and press [ENTER].

- Repeat to enter another character.
- Lower case is also searched.
- Press [◀, ▶] to skip between A, E, I, O and U.
- Press [◀] to erase a character.
- Leave the asterisk (\*) when you search for the titles including the character you enter.
- Erase the asterisk (\*) to search for the titles starting with the character you enter. To add the asterisk (\*) again, display the submenu again and select "Find".

- 3 Press [▶] to select "Find" and press [ENTER].

The search result screen appears.

- 4 Press [▲, ▼] to select the content or group and press [ENTER].

## Playing from the selected track in the CD

CD

Titles appear with CD Text disc playback.

- 1 Press [TOP MENU] or [MENU].

e.g. CD text

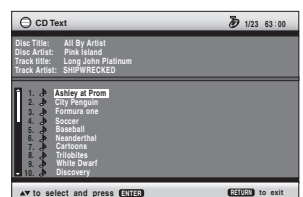

- 2 Press [▲, ▼] to select the track and press [ENTER].

- Press [SHIFT]+[ANGLE/PAGE] to skip page by page.
- Press [FUNCTIONS] to show the playback condition and current position.

- To exit the screen  
Press [TOP MENU] or [MENU].



## Playing HighMAT™ discs

WMA MP3 JPEG

- 1 Press [TOP MENU].
- 2 Press [▲, ▼, ◀, ▶] to select the item, then press [ENTER].
  - Repeat this step if necessary.

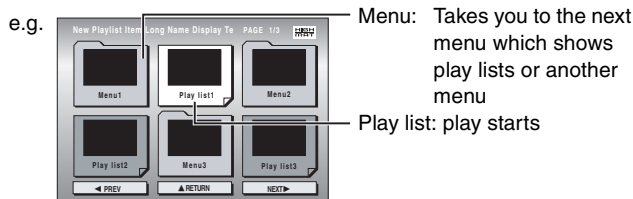

- To change the menu background  
 Press [FUNCTIONS].  
 The background changes to the one recorded on the disc.
- To exit the screen  
 Press [■].

### Selecting from the list

- 1 During play  
 Press [MENU].

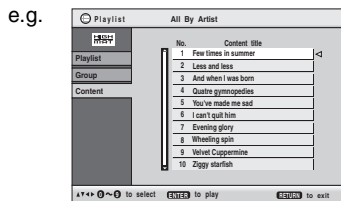

- 2 Press [◀] then [▲, ▼] to switch among “Playlist”, “Group” and “Content” lists.
- 3 Press [▶] then [▲, ▼] to select an item and press [ENTER].
  - Press [SHIFT]+[ANGLE/PAGE] to skip page by page.

- To exit the screen  
 Press [MENU].

### Tips for making WMA/MP3 and JPEG discs (For CD-R, CD-RW)

- Discs must conform to ISO9660 level 1 or 2 (except for extended formats).
- This unit supports multi-session but if there are a lot of sessions it takes more time for play to start. Keep the number of sessions to a minimum to avoid this.
- When there are more than 8 groups, the eighth group onwards will be displayed on one vertical line in the menu screen.
- There may be differences in the display order on the menu screen and computer screen.
- This unit cannot play files recorded using packet write.

### Naming folders and files (Files are treated as content and folders are treated as groups on this unit.)

At the time of recording, prefix folder and file names with 3-digit numbers in the order you want to play them (this may not work at times).

Files must have the extension:

- “WMA” or “.wma”
- “MP3” or “.mp3”
- “JPG”, “.jpg”, “.JPEG” or “.jpeg”

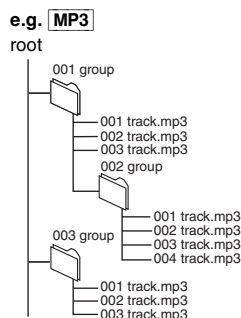

## Playing RAM discs

RAM

- Titles appear only if the titles are recorded on the disc.
- You cannot edit programs, play lists and disc titles.

### Playing the programs

- 1 Press [DIRECT NAVIGATOR].

e.g.

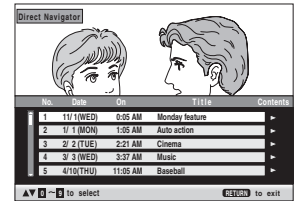

- To exit the screen  
 Press [DIRECT NAVIGATOR].
- 2 Press [▲, ▼] or the numbered buttons to select the program.
    - Press [SHIFT]+[ANGLE/PAGE] to skip page by page.
    - To select a 2-digit number  
 e.g. 23: [≥10] → [2] → [3]
    - Press [▶] to show the contents of the program and the disc.
  - 3 Press [ENTER].

### Playing a play list

(Only when the disc contains a play list)

- 1 Press [PLAY LIST].

e.g.



- To exit the screen  
 Press [PLAY LIST].
- 2 Press [▲, ▼] or the numbered buttons to select the play list.
    - Press [SHIFT]+[ANGLE/PAGE] to skip page by page.
    - To select a 2-digit number  
 e.g. 23: [≥10] → [2] → [3]
  - 3 Press [ENTER].

### WMA

- You cannot play WMA files that are copy protected.
- This unit does not support Multiple Bit Rate (MBR).

### MP3

- This unit does not support ID3 tags.
- Compatible sampling rates: 8, 11.02, 12, 16, 22.05, 24, 32, 44.1 and 48 kHz.

### JPEG

- To view JPEG files on this unit:
  - Take them on a digital camera that meets the DCF Standard (Design rule for Camera File system) Version 1.0. Some digital cameras have functions that are not supported by the DCF Standard Version 1.0 like automatic picture rotation which may render a picture unviewable.
  - Do not alter the files in any way or save them under a different name.
- This unit cannot display moving pictures, MOTION JPEG and other such formats, still pictures other than JPEG (e.g. TIFF) or play pictures with attached audio.

# Using on-screen menus

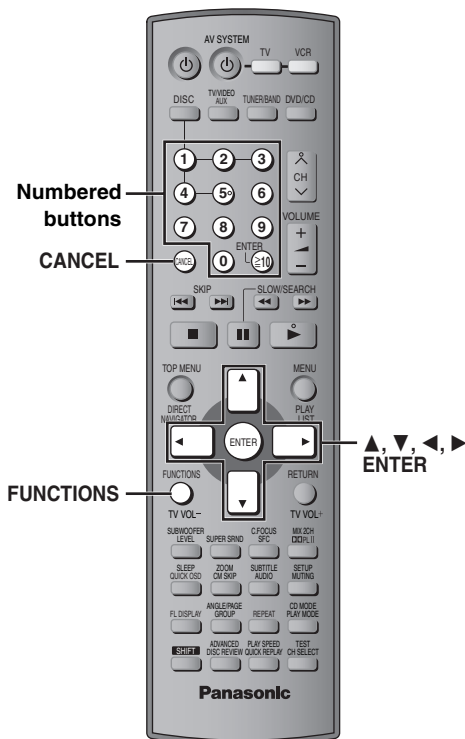

Items shown differ depending on the type of disc.

## Main menu

<b>Program Group</b>	To start from a specific item
<b>Title</b>	
<b>Chapter</b>	
<b>Track</b>	
<b>Playlist</b>	
<b>Content</b>	
<b>Time</b>	To skip incrementally or decrementally* (Time Slip for play only) 1 Press [ENTER] twice to show the Time Slip indicator. 2 Press [▲, ▼] to select the time and press [ENTER]. ● Press and hold [▲, ▼] to alter faster. To start from a specific time* (Time Search) To change remaining/elapsed time display
<b>Audio</b>	(→ page 13, Changing soundtracks) [WMA] [MP3] To display the current disc type
<b>Still Picture</b>	To switch still pictures
<b>Thumbnail</b>	To show thumbnail images
<b>Subtitle</b>	(→ page 13, Changing subtitles)
<b>Marker (VR)</b>	[RAM] To recall a marker recorded on DVD-Video recorders To recall a marker: Press [▲, ▼] → Press [ENTER]
<b>Angle</b>	(with multiple angles) To select the angle
<b>Rotate Picture</b>	To rotate picture
<b>Slideshow</b>	To turn on/off slideshow To change the slideshow timing (0–30 sec)
<b>Other Settings</b>	(→ page 19)

<b>1</b>	FUNCTIONS 	Press once.
<b>2</b>	Select Go to the next menu  Register Return to the previous menu	Select the menu.
<b>3</b>	Select  Register  1 2 3 4 5 6 7 8 9 0 ENTER L R	Make the settings.
<b>4</b>	FUNCTIONS 	Press to exit.

## Other Settings

<b>Play Speed</b>	<b>DVD-A</b> (Motion picture part) <b>RAM</b> <b>DVD-V</b> To change play speed –from “×0.6” to “×1.4” (in 0.1 unit steps)
-------------------	--

### ■ Play Menu

(Only when the elapsed play time can be displayed.)

**JPEG**: Works with all JPEG content.)

<b>Repeat</b>	(→ page 13, Repeat play)
<b>A-B Repeat</b>	Except <b>JPEG</b> <b>RAM</b> (Still picture part) To repeat a specified section Press [ENTER] at the starting and ending points. Press [ENTER] again to cancel.
<b>Marker</b>	Except <b>RAM</b> To mark up to 5 positions to play again Press [ENTER] (The unit is now ready to accept markers.) To mark a position: Press [ENTER] (at the desired point) To mark another position: Press [◀, ▶] to select “*” → Press [ENTER] To recall a marker: Press [◀, ▶] → Press [ENTER] To erase a marker: Press [◀, ▶] → Press [CANCEL] • This feature does not work during program and random play.
<b>Advanced Disc Review</b>	[→ page 12, Reviewing titles to play (ADVANCED DISC REVIEW)]

### ■ Picture Menu

<b>Picture Mode</b>	<b>Normal</b> <b>Cinema1</b> : Mellows images and enhances detail in dark scenes. <b>Cinema2</b> : Sharpens images and enhances detail in dark scenes. <b>Animation Dynamic User</b> (Press [ENTER] to select “Picture Adjustment”) (→ below)
<b>Video Output Mode</b>	<b>480i</b> (Interlace) ↔ <b>480p</b> (Progressive) When you select “480p”, a confirmation screen appears. Select “Yes” only if connecting to a progressive output compatible television.
<b>Transfer Mode</b>	If you have chosen “480p” (→ above), select the method of conversion for progressive output to suit the type of material. <b>Auto1</b> (normal): Detects 24 frame-per-second film content and appropriately converts it. <b>Auto2</b> : Compatible with 30 frame-per-second film content in addition to 24 frame-per-second film content. <b>Video</b> : Select when using Auto1 or Auto2, and the video content is distorted.

### ■ Audio Menu

<b>Dolby Pro Logic II</b>	(→ page 22, Dolby Pro Logic II)
<b>Dialogue Enhancer</b>	To make the dialogue in movies easier to hear <b>DVD-V</b> (Dolby Digital, DTS, MPEG, 3-channel or higher, with the dialogue recorded in the center channel) On ↔ Off
<b>Sound Enhancement</b>	Enhances audio output to produce a warm hall-like sound. On ↔ Off

### ■ Display Menu

<b>Information</b>	<b>JPEG</b> Off, Date, Details
<b>Subtitle Position</b>	0 to –60 (in 2 unit steps)
<b>Subtitle Brightness</b>	Auto, 0 to –7
<b>Just Fit Zoom</b>	To select the appropriate screen size to fit your TV screen
<b>Manual Zoom</b>	To zoom in and out manually
<b>Bit Rate Display</b>	<b>RAM</b> <b>DVD-V</b> <b>VCD</b> <b>DVD-A</b> (Motion picture part) On ↔ Off
<b>GUI See-through</b>	Off, On, Auto
<b>GUI Brightness</b>	–3 to +3

### ■ Other Menu

<b>Setup</b>	(→ page 20)
<b>Play as DVD-Video</b> or <b>Play as DVD-Audio</b>	Select “Play as DVD-Video” to play DVD-Video contents of DVD-Audio.
<b>Play as DVD-VR,</b> <b>Play as HighMAT</b> or <b>Play as Data Disc</b>	Select “Play as Data Disc” to play JPEG files on DVD-RAM or to play a HighMAT disc without using the HighMAT function.

# Changing the player settings

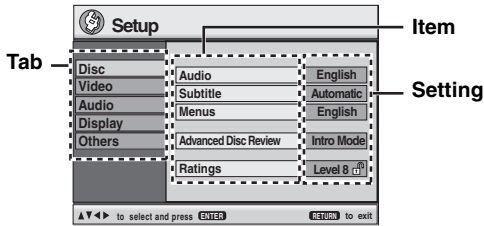
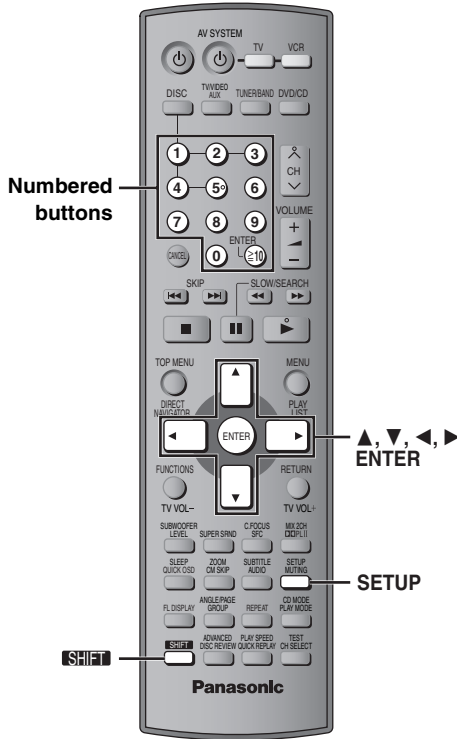

- The settings remain intact even if you switch the unit to standby.
- Underlined items are the factory preset in the following diagram.

<b>1</b>		<b>Show the Setup menu.</b> If you have not set QUICK SETUP (→ page 8), the QUICK SETUP screen appears.
<b>2</b>	Select  Go right 	<b>Select the tab.</b>
<b>3</b>	Select  Register 	<b>Select the item.</b>
<b>4</b>	Select  Register  1 2 3 4 5 6 7 8 9 0 ENTER L (10)	<b>Make the settings.</b>
<b>5</b>		<b>Press to exit.</b>

**QUICK SETUP enables successive settings of the items in the shaded area.**

## ■ “Disc” tab

<b>Audio</b> Choose the audio language.	• <u>English</u> • French    • Spanish    • Original*1    • Other*****#2
<b>Subtitle</b> Choose the subtitle language.	• <u>Automatic</u> *3    • English    • French    • Spanish    • Other*****#2
<b>Menus</b> Choose the language for disc menus. Changing the menu language in QUICK SETUP also changes this setting.	• <u>English</u> • French    • Spanish    • Other*****#2
<b>Advanced Disc Review</b> (→ page 12)	• <b>Intro Mode:</b> Reviews each title/program. • <b>Interval Mode:</b> Reviews not only each title/program but also each 10 minute interval within a title/program.
<b>Ratings</b> Set a ratings level to limit DVD-Video play.	Setting ratings (When level 8 is selected) • <u>8 No Limit</u> • 1 to 7    • 0 Lock All: To prevent play of discs without ratings levels.  When you select your ratings level, a password screen is shown. Follow the on-screen instructions. <b>Do not forget your password.</b> A message screen will be shown if a DVD-Video exceeding the ratings level is inserted in the unit. Enter your password and then follow the on-screen instructions.

\*1 The original language designated on the disc is selected.

\*2 Input a code number referring to the table on page 30.

\*3 If the language selected for “Audio” is not available, subtitles appear in that language (if available on the disc).

## ■ “Video” tab

<b>TV Aspect</b> Choose the setting to suit your television and preference.	• <b>4:3 Pan&amp;Scan:</b> Regular aspect television (4:3) The sides of the widescreen picture are cut off so it fills the screen (unless prohibited by the disc).	
	• <b>4:3 Letterbox:</b> Regular aspect television (4:3) Widescreen picture is shown in the letterbox style.	
	• <b>16:9:</b> Widescreen television (16:9)	

<b>TV Type</b> Select to suit the type of television.	<ul style="list-style-type: none"> <li>• Standard (Direct View TV)</li> <li>• Projection TV</li> </ul>	<ul style="list-style-type: none"> <li>• CRT Projector</li> <li>• Plasma TV</li> </ul>	<ul style="list-style-type: none"> <li>• LCD TV/Projector</li> </ul>
<b>Time Delay</b> When connected with a Plasma display, adjust if you notice the audio is out of sync with the video.	<ul style="list-style-type: none"> <li>• 0ms</li> <li>• 20ms</li> <li>• 40ms</li> <li>• 60ms</li> <li>• 80ms</li> <li>• 100ms</li> </ul>		
<b>Still Mode</b> Specify the type of picture shown when paused.	<ul style="list-style-type: none"> <li>• Automatic</li> <li>• Field: The picture is not blurred, but picture quality is lower.</li> <li>• Frame: Overall quality is high, but the picture may appear blurred.</li> </ul>		
<b>Black Level Control</b> Change the black level of the picture if you connected a television through the COMPONENT VIDEO OUT terminals.	<ul style="list-style-type: none"> <li>• Lighter: When connected through VIDEO OUT or S-VIDEO OUT.</li> <li>• Darker: When connected through COMPONENT VIDEO OUT (Y/Pb/Pr).</li> </ul>		

■ **“Audio” tab**

<b>Dynamic Range Compression</b>	<ul style="list-style-type: none"> <li>• Off</li> <li>• On: Adjusts for clarity even when the volume is low by compressing the range of the lowest sound level and the highest sound level. Convenient for late night viewing. (Only works with Dolby Digital)</li> </ul>
<b>Speaker Settings (→ below)</b> Set the delay time for your center and surround speakers.	<ul style="list-style-type: none"> <li>• Center: 0.0/1.0/2.0/3.0/4.0/5.0 ms</li> <li>• Surround (L/R): 0.0/5.0/10.0/15.0 ms</li> </ul>

■ **“Display” tab**

<b>Menu Language</b>	<ul style="list-style-type: none"> <li>• English</li> <li>• Français</li> <li>• Español</li> </ul>
<b>On-Screen Messages</b>	<ul style="list-style-type: none"> <li>• On</li> <li>• Off</li> </ul>

■ **“Others” tab**

<b>FL Dimmer</b> Changes the brightness of the unit’s display.	<ul style="list-style-type: none"> <li>• Bright</li> <li>• Dim</li> <li>• Auto: The display is dimmed, but brightens when you perform some operations.</li> </ul>
<b>QUICK SETUP</b>	<ul style="list-style-type: none"> <li>• Yes</li> <li>• No</li> </ul>
<b>Re-initialize Setting</b> This returns all values in the Setup menus to the default settings.	<ul style="list-style-type: none"> <li>• Yes: The password screen is shown if “Ratings” (→ page 20) is set. Please enter the same password. After “INIT” on the display disappears, turn the unit off and on again.</li> <li>• No</li> </ul>

## Changing the delay time (Speaker Settings)

**(Effective when playing multi-channel audio)**

(Center and surround speakers only)

For optimum listening with 5.1-channel sound, all the speakers, except for the subwoofer, should be the same distance from the seating position. If you have to place the center or surround speakers closer to the seating position, adjust the delay time to make up for the difference.

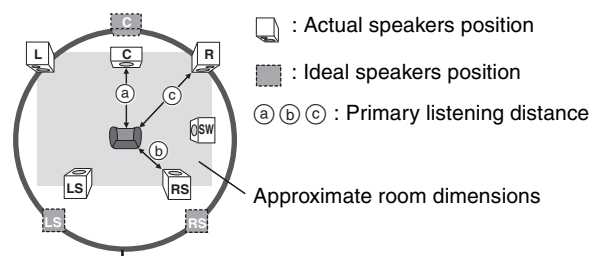

Circle of constant primary listening distance

If either distance (a) or (b) is less than (c), find the difference in the table and change to the recommended setting.

a Center speaker		b Surround speaker	
Difference (Approx.)	Setting	Difference (Approx.)	Setting
30 cm (1 foot)	1.0 ms	150 cm (5 feet)	5.0 ms
60 cm (2 feet)	2.0 ms	300 cm (10 feet)	10.0 ms
90 cm (3 feet)	3.0 ms	450 cm (15 feet)	15.0 ms
120 cm (4 feet)	4.0 ms		
150 cm (5 feet)	5.0 ms		

- 1 Press [▲, ▼] to select the delay time box and press [ENTER].
- 2 Press [▲, ▼] to adjust the delay time and press [ENTER].

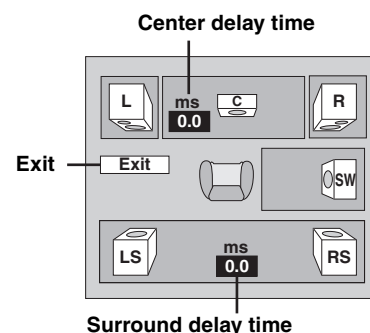

**To finish the speaker setting**

Press [◀] to select “Exit” and press [ENTER].

When you change the surround speaker setting for Dolby Digital, the setting also changes for Dolby Pro Logic II. e.g., the settings for MUSIC are the same as those for Dolby Digital.

Dolby Digital	Dolby Pro Logic II	
	MUSIC	MOVIE
0 ms	0 ms	10 ms
5 ms	5 ms	15 ms
10 ms	10 ms	20 ms
15 ms	15 ms	25 ms

# Sound field and sound quality

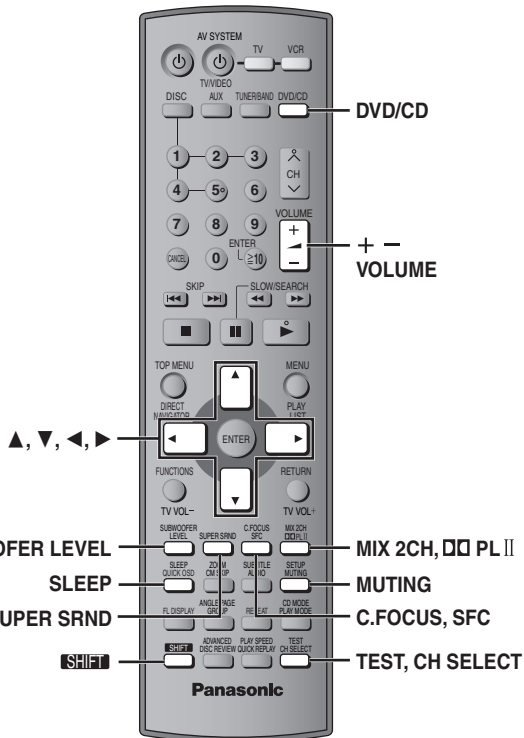

## Note

- When connected with headphones, the following sound field systems have no effect. (Excluding Sound Field Control)
- You may experience a reduction in sound quality when these sound field systems are used with some sources. If this occurs, turn the sound field system off.
- If you turn on Super Surround, Dolby Pro Logic II is canceled and vice versa.

C.FOCUS SFC	<b>Sound Field Control</b>
----------------	----------------------------

Changes the sound quality.

### Press [SFC].

Each time you press the button:

- FLAT:** Cancel (no effect is added) (factory preset).
- HEAVY:** Adds punch to rock.
- CLEAR:** Clarifies higher sounds.
- SOFT:** For background music.
- DISCO:** Reverberates sound to make you feel like you are in a disco.
- LIVE:** Makes vocals more alive.
- HALL:** Expands sound to make you feel like you are in a hall.

### To check the current setting

Press [SFC].

SUPER SRND	<b>Super Surround</b>
------------	-----------------------

Adds surround effects to stereo sound.

### Press [SUPER SRND].

Each time you press the button:

- MUSIC:** Adds surround effects to stereo sources.
- MOVIE:** Use this mode when playing movie software.
- PARTY:** Sound is in stereo regardless of the direction you are facing.
- OFF:** Cancel

- You can adjust the volume of the surround speakers to get the best surround effect (→ page 23, Speaker level adjustments).

- Super Surround does not work when playing a DVD recorded with a multi-channel source.

SHIFT + C.FOCUS SFC	<b>Center Focus</b>
------------------------	---------------------

(Discs where the dialogue is recorded in the center channel)  
You can make the sound of the center speaker seem like it is coming from within the television.

### Press [SHIFT]+[C.FOCUS].

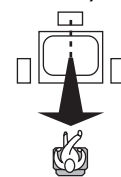

Each time you press the button:

C FOCUS ON ↔ C FOCUS OFF

- This does not work when Super Surround is turned on.
- This also works when Dolby Pro Logic II is turned on.

MIX 2CH DOLBY II	<b>Dolby Pro Logic II</b>
---------------------	---------------------------

Dolby Pro Logic II is an advanced decoder that derives 5-channel surround (Left and Right Front, Center, Left and Right Surround) from any stereo program material, whether or not it has been specifically Dolby Surround encoded.

### Press [DOLBY II].

Each time you press the button:

**MOVIE:** Movie software, recorded in Dolby Surround.

**MUSIC:** Stereo sources

**OFF:** Cancel

- This works only in DVD/CD mode.
- "DOLBY II" lights when there is effect.



SHIFT + MIX 2CH DOLBY II	<b>Down-mixing</b>
-----------------------------	--------------------

You can output the down-mixed 2 channel signals when necessary.

### Press [SHIFT]+[MIX 2CH].



Each time you press the button:

MIX 2CH ON ↔ MIX 2CH OFF

- When "D.MIX" flashes on the display, the disc contains multiple-channel signals that cannot be down-mixed. **DVD-A**

SUBWOOFER LEVEL	<b>Subwoofer level</b>
--------------------	------------------------

You can adjust the amount of bass. The unit automatically selects the most suitable setting according to the type of playing source.

### Press [SUBWOOFER LEVEL].

• When DVD-Video or DVD-RAM is selected  
SUB W 4 (factory preset) → SUB W 1 → SUB W 2 → SUB W 3

• When another source is selected  
SUB W 2 (factory preset) → SUB W 3 → SUB W 4 → SUB W 1



The setting you make is retained, and recalled every time you play the same type of source.

## Speaker level adjustments

This is one of the ways to get appropriate surround effects.

### Preparation

Press [DVD/CD].

- 1** While stopped and no on-screen display is shown  
Press [SHIFT]+[TEST] to output a test signal.  
L: Front left      C: Center      R: Front right  
RS: Right surround    LS: Left surround  
• There is no output from SW (subwoofer) channel.
- 2** Press [VOLUME, +] or [-] to set the volume level normally used for listening.
- 3** Press [▲] (increase) or [▼] (decrease) to adjust the speaker level for each speaker.  
C, RS, LS: -6 dB to +6 dB  
(L, R: Only the balance is adjustable.)  
• **To adjust the balance of the front speakers**  
While outputting the test signal, press [◀, ▶].  
• Adjust the speaker level to the same level as the front speakers.

### To stop the test signal

Press [SHIFT]+[TEST] again.

- **To adjust speaker level during play**  
(Effective when playing multi-channel audio or when Dolby Pro Logic II or Super Surround is on.)

- 1** Press [CH SELECT] to select the speaker.  
L → C → R → RS → LS → SW  
↑  
SW: Subwoofer  
• You can adjust SW only if the disc includes a subwoofer channel.  
• "SW" does not appear on the display and is not adjustable when Dolby Pro Logic II is turned on.  
• "S" appears on the display when "MUSIC" or "MOVIE" is selected with Super Surround (→ page 22). In this case, you can adjust both surround speaker levels at the same time using [▲, ▼].  
S: -6 dB to +6 dB
- 2** Press [▲] (increase) or [▼] (decrease) to adjust the speaker level for each speaker.  
C, RS, LS, SW: -6 dB to +6 dB  
(L, R: Only the balance is adjustable.)  
• **To adjust the balance of the front speakers**  
While "L" or "R" is selected, press [◀, ▶].

## Sleep timer

Press [SHIFT]+[SLEEP] to select the time (in minutes).

SLEEP 30 → SLEEP 60 → SLEEP 90  
↑                      ↓  
OFF ← SLEEP 120 ←



### To cancel the timer

Press [SHIFT]+[SLEEP] to select "OFF".

### To confirm the remaining time

Press [SHIFT]+[SLEEP] again.

### To change the setting

Repeat the procedure from the beginning.

## Muting

Press [MUTING].

"MUTING" flashes on the unit's display.



### To cancel

- Press [MUTING] again or reduce the volume to minimum (--- dB), then raise it to the required level.
- Muting is canceled when you switch the unit to standby.

## Using headphones

### Main unit only

- 1** Reduce the volume and connect the headphones (not included).

Headphone plug type: 3.5 mm (1/8") stereo

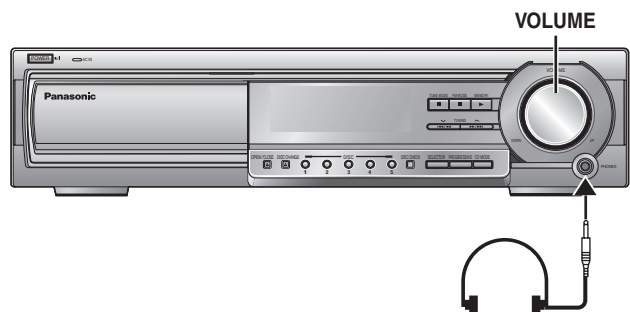

- 2** Adjust headphone volume with [VOLUME].

- Audio is automatically switched to stereo (2-channel).

### Note

Avoid listening for prolonged periods of time to prevent hearing damage.

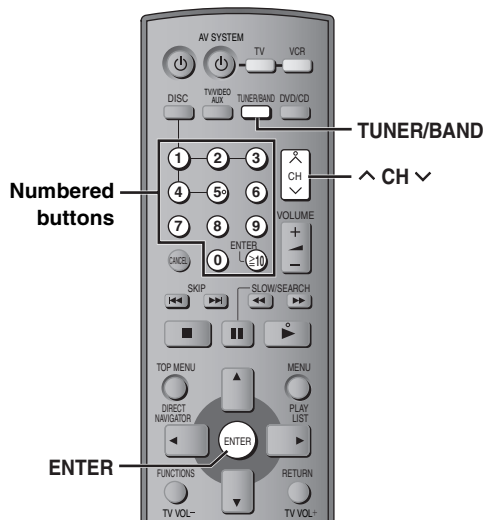
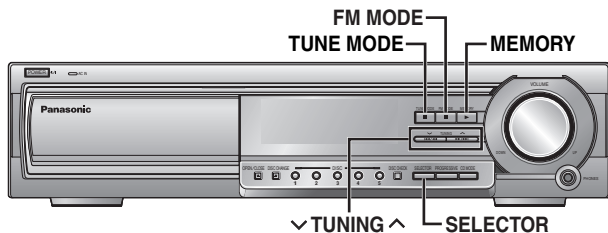

## Automatic presetting

### Main unit only

Up to 15 stations can be set in each band, FM and AM.

- 1 Press [SELECTOR] to select "FM" or "AM".
- 2 Press [TUNE MODE] to select "MANUAL".  
Each time you press the button: MANUAL ↔ PRESET
- 3 Press [v TUNING ^] to tune to the lowest frequency (FM: 87.9 or 87.5, AM: 520).
- 4 Press and hold [MEMORY].

Release the button when "FM AUTO" or "AM AUTO" is displayed.

The tuner presets all the stations it can receive into the channels in ascending order.

- "SET OK" is displayed when the stations are set, and the radio tunes to the last preset station.
- "ERROR" is displayed when automatic presetting is unsuccessful. Preset the channels manually (→ below).

## Manual tuning

### Main unit only

- 1 Press [SELECTOR] to select "FM" or "AM".
- 2 Press [TUNE MODE] to select "MANUAL".
- 3 Press [v TUNING ^] to select the frequency.

Press and hold [v TUNING ^] until the frequency starts scrolling to start automatic tuning. Tuning stops when a station is found.

### ■ Presetting the channel

Up to 15 stations can be set in each band, FM and AM.

- 1 While listening to the radio broadcast Press [ENTER].
- 2 While the frequency and "PGM" are flashing on the display Press the numbered buttons to select a channel.  
Alternatively, press [^ CH v], then press [ENTER].  
• To select a 2-digit number  
e.g. 12: [≥10] → [1] → [2].



The station occupying a channel is erased if another station is preset to that channel.

## Selecting the preset channels

- 1 Press [TUNER/BAND] to select "FM" or "AM".
- 2 Press the numbered buttons to select the channel.

Alternatively, press [^ CH v]

To select a 2-digit number

e.g. 12: [≥10] → [1] → [2]



When a stereo FM broadcast is being received.



### ■ If noise is excessive in FM

#### Main unit only

Press [FM MODE] to display "MONO".



Press [FM MODE] again to cancel the mode.

The mode is also canceled when you change the frequency.

### ■ FM frequency step

#### Main unit only

You can change the FM step. The step is factory-set to 0.2 MHz, but you can change it to receive broadcasts allocated in 0.1-MHz steps.

- 1 Press [SELECTOR] to select "FM".
- 2 Press and hold [SELECTOR].  
After a few seconds the display changes to show the current minimum frequency. Continue to hold the button down. The minimum frequency changes and the step is changed.  
To return to the original step, repeat the above steps.

#### Note

Any FM/AM frequencies preset in channels will be changed by this procedure. Preset them again.



# Operating other equipment

## ■ Connection example

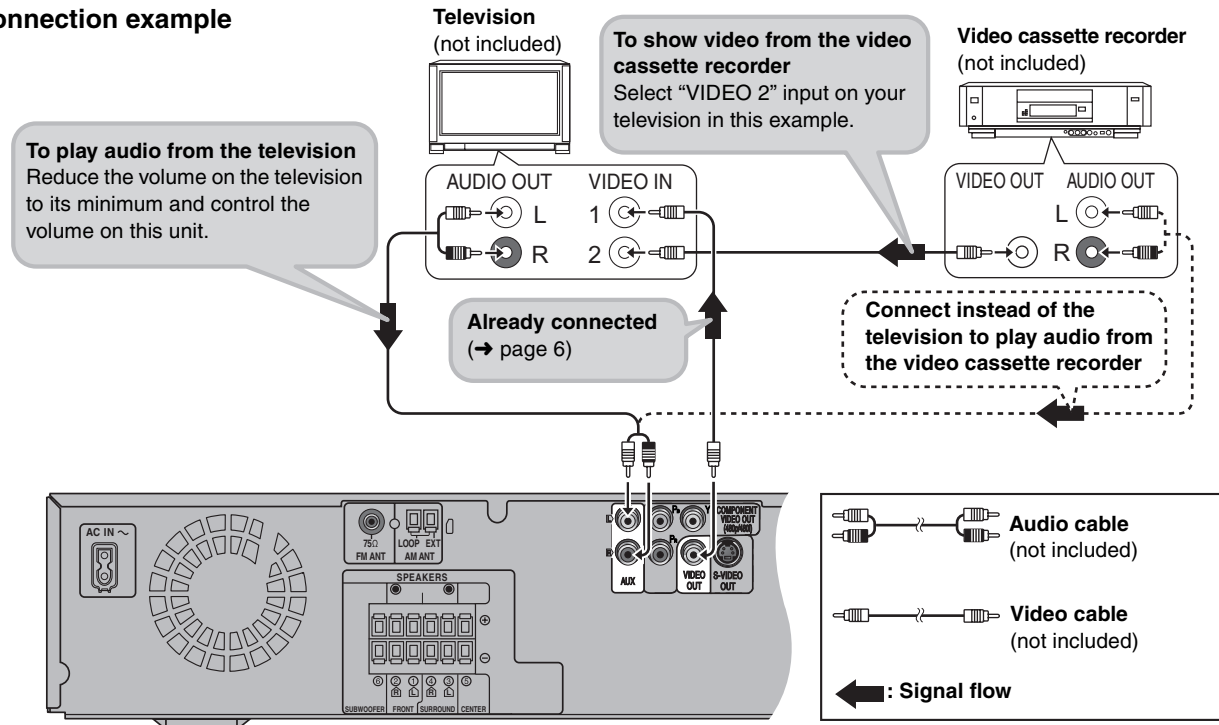

## Operating the television and the video cassette recorder

You can use the remote control to operate a Panasonic television or a video cassette recorder. Connect your equipment referring to "Connection example" (→ above).

### Note

The remote control may not work properly with some models.

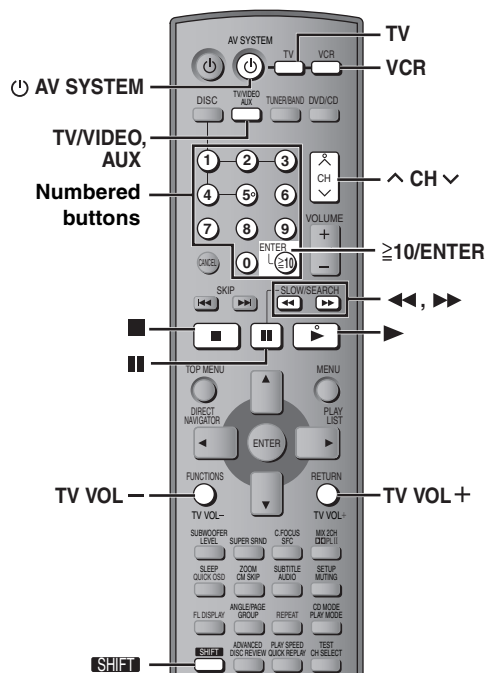

### Video cassette recorder

#### Preparation

- Change the video input mode on the television ("VIDEO 2" in the example).
- Aim the remote control at the unit and press [VCR] to light up the button, and then aim it at the video cassette recorder for the following operations:

#### Turning the video cassette recorder on/off

Press [AV SYSTEM].

#### Play, pause and stop

Press [▶] (play), [⏸] or [■].

#### Fast forward and rewind

Press [◀◀] or [▶▶].

#### Connecting a laser disc, tape or record player

Connect instead of a video cassette recorder (→ above) and select "AUX" as the source.

We recommend using a record player with a built-in phono equalizer. If your player doesn't have a built-in equalizer, connect it first to a separate equalizer and then to the unit.

### Television

#### Preparation

Aim the remote control at the unit and press [TV] to light up the button, and then aim it at the television for the following operations:

#### Turning the television on/off

Press [AV SYSTEM].

#### Switching the television's video input mode

Press [SHIFT]+[TV/VIDEO].

#### Changing channels

Press [^ CH v].

- [≥10/ENTER] is used to confirm channel selection on some televisions manufactured by other companies.

#### Adjusting the volume

Press [TV VOL-] or [TV VOL+].

### Changing the remote control code

This remote control can also operate some other brands of televisions and video cassette recorders. Change the code to operate such equipment (→ back cover).

#### Aim the remote control at the equipment.

While pressing [TV] or [VCR]

#### Press a numbered button to enter the first digit, and then the second digit.

The remote control outputs the on/off signal. If the code is correct, the equipment turns on or off. If it doesn't, try entering another code.

### Note

Reenter the codes after you change the batteries.

# Other speaker setup options

## ■ Attaching to a wall

You can attach all of the speakers to a wall.

- 1 Drive a screw (not included) into the wall.
- 2 Fit the speaker securely onto the screw(s) with the hole(s).

- The wall or pillar on which the speakers are to be attached should be capable of supporting 10 kg (22 lbs) per screw. Consult a qualified building contractor when attaching the speakers to a wall. Improper attachment may result in damage to the wall and speakers.
- Use of optional speaker cables is recommended for wall-mounted front speakers. (You can also remove the speaker cables from the pipes supplied with this system).

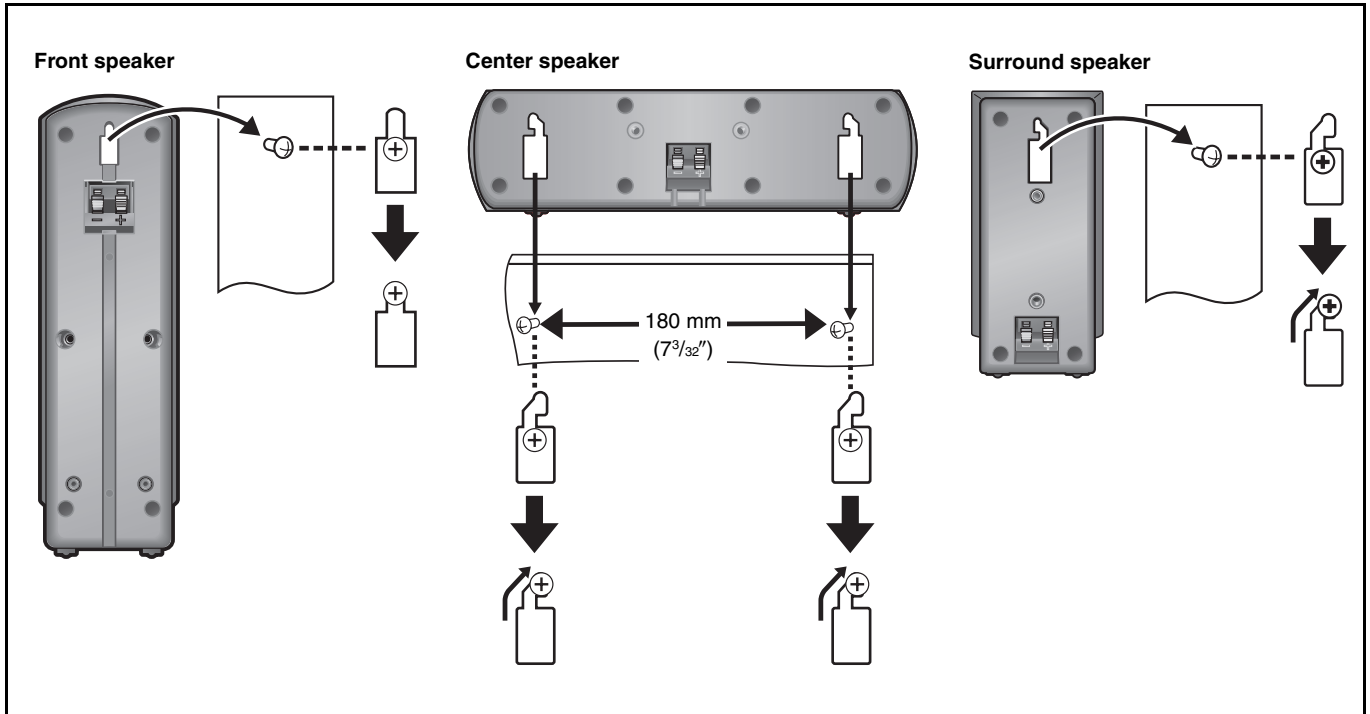
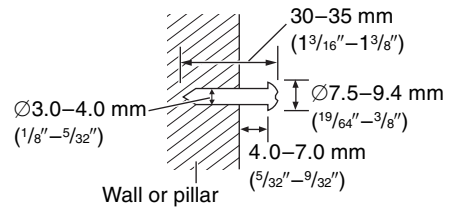

In this position, the speaker will likely fall if moved to the left or right.



Move the speaker so the screw is in this position.

## ■ Fitting speaker stands (not included) (Except Front speakers)

Ensure the stands meet these conditions before purchasing them.

Note the diameter and length of the screws and the distance between screws as shown in the diagram.

- The stands must be able to support over 10 kg (22 lbs).
- The stands must be stable even if the speakers are in a high position.

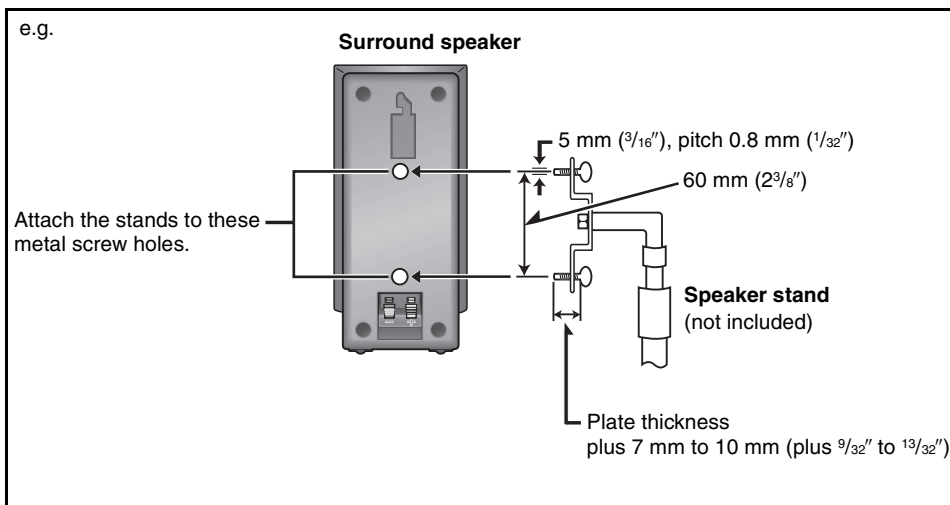

## AMPLIFIER SECTION

### RMS Output Power: Dolby Digital Mode

Front Ch	55 W per channel (6 Ω), 1 kHz, 10 % THD
Surround Ch	55 W per channel (6 Ω), 1 kHz, 10 % THD
Center Ch	160 W per channel (6 Ω), 1 kHz, 10 % THD
Subwoofer Ch	220 W per channel (4 Ω), 100 Hz, 10 % THD
Total RMS Dolby Digital mode power	600 W

### FTC Output Power: Dolby Digital Mode

Front Ch	35 W per channel (6 Ω), 120 Hz–20 kHz, 1 % THD
Surround Ch	35 W per channel (6 Ω), 120 Hz–20 kHz, 1 % THD
Center Ch	110 W per channel (6 Ω), 120 Hz–20 kHz, 1 % THD
Subwoofer Ch	140 W per channel (4 Ω), 45 Hz–120 Hz, 1 % THD
Total FTC Dolby Digital mode power	390 W

## FM/AM TUNER, TERMINALS SECTION

<b>Preset station</b>	FM 15 stations AM/MW 15 stations
-----------------------	-------------------------------------

### Frequency Modulation (FM)

Frequency range	87.9–107.9 MHz (200-kHz step) 87.5–108.0 MHz (100-kHz step)
Sensitivity	2.5 μV (IHF)
S/N 26 dB	2.2 μV
Antenna terminals	75 Ω (unbalanced)

### Amplitude Modulation (AM/MW)

Frequency range	520–1710 kHz (10-kHz step)
AM Sensitivity S/N 20 dB at 1000 kHz	560 μV/m

### Phone jack

Terminal	Stereo, 3.5 mm (1/8") jack
----------	----------------------------

## DISC SECTION

### Discs played [8 cm (3") or 12 cm (5")]

- DVD-RAM (DVD-VR compatible, JPEG formatted discs)
- DVD-Audio
- DVD-Video
- DVD-R, DVD-RW (DVD-Video compatible)  
+ R, + RW (Video compatible)
- CD-Audio (CD-DA)
- Video CD
- SVCD (Conforming to IEC62107)
- CD-R/RW (CD-DA, Video-CD, SVCD, MP3, WMA, JPEG formatted disc)
- MP3/WMA\*<sup>1</sup>
  - Compatible compression rate:  
MP3: between 32 kbps and 320 kbps  
WMA: between 48 kbps and 320 kbps
- JPEG\*<sup>1</sup>
  - Exif Ver 2.1 JPEG Baseline files
  - Picture resolution: between 320×240 and 6144×4096 pixels (sub sampling is 4:2:2 or 4:2:0)
- HighMAT Level 2 (Audio and Image)

\*<sup>1</sup>The total combined maximum number of recognizable audio and picture contents and groups: 4000 audio and picture contents and 400 groups.

### Pick up

Wavelength	CD 785 nm DVD 662 nm
Laser power	<b>U.S.A.</b> CLASS IIa/CLASS I <b>Canada</b> CLASS 2/CLASS 3A

### Audio output (Disc)

Number of channels	5.1ch (FL, FR, C, SL, SR, SW)
--------------------	-------------------------------

## VIDEO SECTION

### Video system

Signal system	NTSC
---------------	------

### Composite video output

Output level	1 Vp-p (75 Ω)
Terminal	Pin jack (1 system)

### S-video output

Y output level	1 Vp-p (75 Ω)
C output level	NTSC; 0.286 Vp-p (75 Ω)
Terminal	S terminal (1 system)

### Component video output (480p/480i)

Y output level	1 Vp-p (75 Ω)
P <sub>B</sub> output level	0.7 Vp-p (75 Ω)
P <sub>R</sub> output level	0.7 Vp-p (75 Ω)
Terminal	Pin jack (Y: green, P <sub>B</sub> : blue, P <sub>R</sub> : red) (1 system)

## SPEAKER SECTION

### Front speakers SB-FS680

<b>Type</b>	2 way, 2 speaker system (Bass reflex)
<b>Speaker unit(s)</b>	Impedance 6 Ω
1. Full range	6.5 cm (2 1/2") Cone type
2. Super tweeter	Piezo type
<b>Input power (IEC)</b>	55 W (Max)
<b>Output sound pressure</b>	80 dB/W (1.0 m)
Cross over frequency	10 kHz
<b>Frequency range</b>	80 Hz–22 kHz (–16 dB) 95 Hz–20 kHz (–10 dB)
<b>Dimensions (W×H×D)</b>	218 mm×1080 mm (Max)/984 mm (Min)×243 mm (8 19/32"×42 1/2" (Max)/38 3/4" (Min)×9 9/16")
<b>Mass</b>	2.6 kg (5.7 lbs)

### Surround speakers SB-FS681

<b>Type</b>	1 way, 1 speaker system (Bass reflex)
<b>Speaker unit(s)</b>	Impedance 6 Ω
Full range	6.5 cm (2 1/2") Cone type
<b>Input power (IEC)</b>	55 W (Max)
<b>Output sound pressure</b>	80 dB/W (1.0 m)
<b>Frequency range</b>	88 Hz–25 kHz (–16 dB) 100 Hz–22 kHz (–10 dB)
<b>Dimensions (W×H×D)</b>	90 mm×193 mm×102 mm (3 17/32"×7 19/32"×4 1/32")
<b>Mass</b>	0.7 kg (1.54 lbs)

### Center speaker SB-PC680

<b>Type</b>	2 way, 3 speaker system (Bass reflex)
<b>Speaker unit(s)</b>	Impedance 6 Ω
1. Full range	6.5 cm (2 1/2") Cone type
2. Full range	6.5 cm (2 1/2") Cone type
3. Super tweeter	Piezo type
<b>Input power (IEC)</b>	160 W* (Max)
<b>Output sound pressure</b>	83 dB/W (1.0 m)
Cross over frequency	10 kHz
<b>Frequency range</b>	103 Hz–25 kHz (–16 dB) 116 Hz–22 kHz (–10 dB)
<b>Dimensions (W×H×D)</b>	320 mm×88 mm×96 mm (12 19/32"×3 15/32"×3 25/32")
<b>Mass</b>	1.3 kg (2.9 lbs)

### Subwoofer SB-W680

<b>Type</b>	1 way, 1 speaker system (Bass reflex)
<b>Speaker unit(s)</b>	Impedance 4 Ω
Subwoofer	17 cm (6 3/4") Cone type
<b>Input power (IEC)</b>	220 W (Max)
<b>Output sound pressure</b>	86 dB/W (1.0 m)
<b>Frequency range</b>	35 Hz–500 Hz (–16 dB) 50 Hz–250 Hz (–10 dB)
<b>Dimensions (W×H×D)</b>	270 mm×287 mm×283 mm (10 5/8"×11 5/16"×11 5/32")
<b>Mass</b>	4.1 kg (9 lbs)

## GENERAL

<b>Power supply</b>	120 V, 60 Hz
<b>Power consumption</b>	Main unit 280 W
<b>Dimensions (W×H×D)</b>	430 mm×105 mm×381 mm (16 15/16"×4 1/8"×15")
<b>Mass</b>	Main unit 7.1 kg (15.7 lbs)
<b>Operating temperature range</b>	+5 °C to +35 °C (+41 °F to +95 °F)
<b>Operating humidity range</b>	5 % to 90 % RH (no condensation)

<b>Power consumption in standby mode</b>	approx. 0.5 W
--	---------------

\* Rating with low cut filter equipped amplifier

### Note

- Specifications are subject to change without notice. Mass and dimensions are approximate.
- Total harmonic distortion is measured by a digital spectrum analyzer.

# Troubleshooting guide

Before requesting service, make the following checks. If you are in doubt about some of the check points, or if the solutions indicated in the chart do not solve the problem, refer to the "Customer Services Directory" on page 31 if you reside in the U.S.A., or refer to the "Product information" on page 30 if you reside in Canada.

Power		Page
No power.	● Insert the AC power supply cord securely.	7
The unit is automatically switched to the standby mode.	● The Sleep timer was working and had reached the set time limit.	23

## Unresponsive or inoperable function

No response when any buttons are pressed.	<ul style="list-style-type: none"> <li>● This unit cannot play discs other than the ones listed in these operating instructions.</li> <li>● The unit may not be operating properly due to lightning, static electricity or some other external factor. Turn the unit off and then back to ON. Alternatively, turn the unit off, disconnect the AC power supply cord, and then reconnect it.</li> <li>● Condensation has formed: Wait 1 to 2 hours for it to evaporate.</li> </ul>	9 —
No response when remote control buttons are pressed.	<ul style="list-style-type: none"> <li>● Check that the batteries are installed correctly.</li> <li>● The batteries are depleted. Replace them with new ones.</li> <li>● Aim the remote control at the display and operate.</li> </ul>	7 7 8
Cannot play DVD's.	● CD Mode is on. Press [SHIFT]+[CD MODE] to turn CD Mode off.	12
No picture or sound.	<ul style="list-style-type: none"> <li>● Check the video or audio connection.</li> <li>● Check the power or input setting of the connected equipment.</li> <li>● Check that the DVD-RAM has something recorded on it.</li> </ul>	4, 6, 25 — —
You have forgotten your ratings password. Reset all the settings to Factory Preset.	● While stopped and "DVD/CD" is the source, press and hold [■] on the main unit and [≥10] on the remote control until "Initialized" disappears from the television. Turn the unit off and on again. All settings will return to the default values.	—

## Specific operation undesirable or unexpected

It takes time before play starts. <b>MP3</b>	● Play may take time to begin when an MP3 track has still picture data. Even after the track starts, the correct play time will not be displayed. This is normal.	—
Folders deeper than the eighth layer on a data CD are not displayed correctly. <b>WMA MP3 JPEG</b>	● Folders deeper than the eighth layer are displayed as the eighth layer.	—
A menu screen appears during skip or search. <b>VCD</b>	● This is normal for Video CD's.	—
Playback control menu doesn't appear. <b>VCD</b> with playback control	● Press [■] twice and then press [▶] (play).	—
The program and random play functions do not work. <b>DVD-V</b>	● These functions do not work with some DVD-Videos.	—
Programmed items are not played. <b>DVD-V</b>	● Some items cannot be played even if you have programmed them.	—
The on-screen menu shows "2" as a soundtrack option when [AUDIO] is pressed, but the audio does not change. <b>DVD-A</b>	● Even if a second soundtrack isn't recorded, two numbers will normally be shown.	—
Play restarts from the beginning of the track when soundtrack is changed. <b>DVD-A</b>	● This is normal on DVD-Audio.	—
Scenes are skipped intermittently. <b>RAM DVD-V</b>	● If you change the volume or sound field/quality setting during ADVANCED DISC REVIEW, the function continues without the on-screen display. Press [ADVANCED DISC REVIEW] again to cancel the function.	12

## Subtitle

Subtitle position is wrong.	● Adjust the position. ("Subtitle Position" in Display Menu)	19
No subtitles.	● Display the subtitles.	13
The subtitles overlap closed captions recorded on discs.	● Clear the subtitles.	13

## Marker

Cannot add markers.	<ul style="list-style-type: none"> <li>● You cannot add markers with DVD-RAM.</li> <li>● If the disc's elapsed play time doesn't appear on the unit's display, you cannot add markers.</li> </ul>	— —
---------------------	---	--------

## A-B repeat

Point B is automatically set.	● The end of an item becomes point B when it is reached.	—
A-B repeat is automatically canceled.	● A-B repeat is canceled when you press [QUICK REPLAY].	—

## Sound abnormal or improper

Sound distorted.	● Noise may occur when playing WMA.	—
Effects do not work.	<ul style="list-style-type: none"> <li>● Some audio effects do not work or have less effect with some discs.</li> <li>● Dolby Pro Logic II does not work if you have changed the play speed.</li> </ul>	— —
Humming is heard during play.	● An AC power supply cord or fluorescent light is near the cables. Keep other appliances and cords away from this unit's cables.	—
No sound	● There may be a pause in sound when you change the play speed.	—

## Menus

Page

The Setup menu cannot be accessed.	<ul style="list-style-type: none"> <li>Select "DVD/CD" as the source.</li> <li>Cancel program and random play.</li> </ul>	— 14
------------------------------------	---	---------

## Picture abnormal or unviewable

Picture distorted.	<ul style="list-style-type: none"> <li>Ensure that the unit is connected directly to the television, and is not connected through a video cassette recorder.</li> </ul>	6
Picture size doesn't fit the screen.	<ul style="list-style-type: none"> <li>Change "TV Aspect" in the "Video" tab.</li> <li>Change the Zoom setting.</li> </ul>	20 13
Menu is not displayed correctly.	<ul style="list-style-type: none"> <li>Restore the zoom ratio to "×1.00".</li> <li>Set "Subtitle Position" in Display Menu to "0".</li> </ul>	13 19
Auto zoom function does not work well.	<ul style="list-style-type: none"> <li>Turn off TV's zoom function.</li> <li>Use the other preset aspect ratios or manual adjustment.</li> <li>Zoom function may not work well, especially in dark scenes and may not work depending on the type of disc.</li> </ul>	— 13 —
The picture on the television disappears or stripes appear on the screen.	<ul style="list-style-type: none"> <li>Mobile telephone chargers can cause some disturbance.</li> <li>If you are using a TV indoor antenna, change to an outdoor antenna.</li> <li>The television antenna wire is too close to the unit. Separate the antenna wire of the television from the unit.</li> </ul>	— — —

## Progressive video

There is ghosting when progressive output is on.	<ul style="list-style-type: none"> <li>This problem is caused by the editing method or material used on DVD-Video, but should be corrected if you use interlace output. Change "Video Output Mode" in Picture Menu to "480i".</li> </ul>	19
Pictures not in progressive output.	<ul style="list-style-type: none"> <li>Press [PROGRESSIVE] on the main unit so "PRG" is displayed. Or select "480p" in "Video Output Mode" in Picture Menu.</li> <li>If the unit is connected to the television through VIDEO OUT or S-VIDEO OUT terminal, output will be interlace, even if "PRG" is displayed.</li> </ul>	10, 19 6
Closed captions not displayed.	<ul style="list-style-type: none"> <li>When progressive output is on, closed captions will not be displayed.</li> </ul>	—

## Listening to the radio

Noise is heard. "ST" flickers or doesn't light. Sound is distorted.	<ul style="list-style-type: none"> <li>Adjust the position of the FM or AM antenna.</li> <li>Use an outdoor antenna.</li> </ul>	— 7
A beat sound is heard.	<ul style="list-style-type: none"> <li>Turn the television off or move it away from the unit.</li> </ul>	—
A low hum is heard during AM broadcasts.	<ul style="list-style-type: none"> <li>Separate the antenna from other cables.</li> </ul>	—

## Television operation

Cannot operate the TV.	<ul style="list-style-type: none"> <li>Press [TV] first to operate the television.</li> <li>Check the remote control code for the TV manufacturer.</li> </ul>	— 25
------------------------	---	---------

## Unit displays

The display is dark.	<ul style="list-style-type: none"> <li>Select "Bright" in "FL Dimmer" in the "Others" tab.</li> </ul>	21
"NO PLAY"	<ul style="list-style-type: none"> <li>You inserted a disc the unit cannot play; insert one it can.</li> <li>You inserted a blank disc.</li> </ul>	9 —
"NO DISC"	<ul style="list-style-type: none"> <li>You haven't inserted a disc; insert one.</li> <li>You haven't inserted the disc correctly; insert it correctly.</li> </ul>	— 9
"F61"	<ul style="list-style-type: none"> <li>Check and correct the speaker cord connections. If this does not fix the problem, there is a power supply problem. Consult the dealer.</li> </ul>	4, 6
"DVD U11"	<ul style="list-style-type: none"> <li>Disc is dirty. Wipe it clean.</li> </ul>	9
"ERROR"	<ul style="list-style-type: none"> <li>Incorrect operation performed. Read the instructions and try again.</li> </ul>	—
"DVD H□□" □□ stands for a number.	<ul style="list-style-type: none"> <li>Trouble may have occurred. The number following "H" depends on the status of the unit. Turn the unit off and then back to ON. Alternatively, turn the unit off, disconnect the AC power supply cord, and then reconnect it.</li> <li>If the service numbers fail to clear, note the service number and contact a qualified service person.</li> </ul>	— —

## Television displays

"⊘"	<ul style="list-style-type: none"> <li>The operation is prohibited by the unit or disc.</li> </ul>	—
"Cannot display group xx, content xx"	<ul style="list-style-type: none"> <li>You are trying to display incompatible contents.</li> </ul>	—
"This disc may not be played in your region"	<ul style="list-style-type: none"> <li>You can only play DVD-Video if their region number is the same or includes the same region number as the unit or if the DVD-Video is marked "ALL". Confirm the region number for the unit on the rear panel.</li> </ul>	Cover page
No on-screen display.	<ul style="list-style-type: none"> <li>Select "On" in "On-Screen Messages" in the "Display" tab.</li> </ul>	21

- 1. Damage requiring service**—The unit should be serviced by qualified service personnel if:
  - (a) The AC power supply cord or AC adaptor has been damaged; or
  - (b) Objects or liquids have gotten into the unit; or
  - (c) The unit has been exposed to rain; or
  - (d) The unit does not operate normally or exhibits a marked change in performance; or
  - (e) The unit has been dropped or the cabinet damaged.
- 2. Servicing**—Do not attempt to service the unit beyond that described in these operating instructions. Refer all other servicing to authorized servicing personnel.
- 3. Replacement parts**—When parts need replacing ensure the servicer uses parts specified by the manufacturer or parts that have the same characteristics as the original parts. Unauthorized substitutes may result in fire, electric shock, or other hazards.
- 4. Safety check**—After repairs or service, ask the servicer to perform safety checks to confirm that the unit is in proper working condition. The servicer will require all components to service your system. Therefore, should service ever be necessary, be sure to bring the entire system.

## Product information

For product information or assistance with product operation: **In the U.S.A., refer to "Customer Services Directory" on page 31. In Canada, contact the Panasonic Canada Inc. Customer Care Centre at 1-800-561-5505, or visit the website ([www.panasonic.ca](http://www.panasonic.ca)), or an authorized Servicentre closest to you.**

The model number and serial number of this product can be found on either the back or the bottom of the unit. Please note them in the space provided below and keep for future reference.

MODEL NUMBER \_\_\_\_\_ SC-HT680 \_\_\_\_\_  
 SERIAL NUMBER \_\_\_\_\_

## User memo:

DATE OF PURCHASE \_\_\_\_\_  
 DEALER NAME \_\_\_\_\_  
 DEALER ADDRESS \_\_\_\_\_  
 TELEPHONE NUMBER \_\_\_\_\_

# Maintenance

## Clean this unit with a soft, dry cloth.

- Never use alcohol, paint thinner or benzine to clean this unit.
- Before using chemically treated cloth, carefully read the instructions that came with the cloth.

**Do not use commercially available lens cleaners as they may cause malfunction.** (Cleaning the lens is generally not necessary although this depends on the operating environment.)

## Before moving the unit, ensure the disc trays are empty.

Failure to do so will risk severely damaging the discs and the unit.

## Language code list

Abkhazian: 6566	Chinese: 9072	Hausa: 7265	Lithuanian: 7684	Romanian: 8279	Telugu: 8469
Afar: 6565	Corsican: 6779	Hebrew: 7387	Macedonian: 7775	Russian: 8285	Thai: 8472
Afrikaans: 6570	Croatian: 7282	Hindi: 7273	Malagasy: 7771	Samoaan: 8377	Tibetan: 6679
Albanian: 8381	Czech: 6783	Hungarian: 7285	Malay: 7783	Sanskrit: 8365	Tigrinya: 8473
Ameharic: 6577	Danish: 6865	Icelandic: 7383	Malayalam: 7776	Scots Gaelic: 7168	Tonga: 8479
Arabic: 6582	Dutch: 7876	Indonesian: 7378	Maltese: 7784	Serbian: 8382	Turkish: 8482
Armenian: 7289	English: 6978	Interlingua: 7365	Maori: 7773	Serbo-Croatian: 8372	Turkmen: 8475
Assamese: 6583	Esperanto: 6979	Irish: 7165	Marathi: 7782	Shona: 8378	Twi: 8487
Aymara: 6588	Estonian: 6984	Italian: 7384	Moldavian: 7779	Sindhi: 8368	Ukrainian: 8575
Azerbaijani: 6590	Faroese: 7079	Japanese: 7465	Mongolian: 7778	Singhalese: 8373	Urdu: 8582
Bashkir: 6665	Fiji: 7074	Javanese: 7487	Nauru: 7865	Slovak: 8375	Uzbek: 8590
Basque: 6985	Finnish: 7073	Kannada: 7578	Nepali: 7869	Slovenian: 8376	Vietnamese: 8673
Bengali; Bangla: 6678	French: 7082	Kashmiri: 7583	Norwegian: 7879	Somali: 8379	Volapük: 8679
Bhutani: 6890	Frisian: 7089	Kazakh: 7575	Oriya: 7982	Spanish: 6983	Welsh: 6789
Bihari: 6672	Galician: 7176	Kirghiz: 7589	Pashto, Pushto: 8083	Sundanese: 8385	Wolof: 8779
Breton: 6682	Georgian: 7565	Korean: 7579	Persian: 7065	Swahili: 8387	Xhosa: 8872
Bulgarian: 6671	German: 6869	Kurdish: 7585	Polish: 8076	Swedish: 8386	Yiddish: 7473
Burmese: 7789	Greek: 6976	Laotian: 7679	Portuguese: 8084	Tagalog: 8476	Yoruba: 8979
Byelorussian: 6669	Greenlandic: 7576	Latin: 7665	Punjabi: 8065	Tajik: 8471	Zulu: 9085
Cambodian: 7577	Guarani: 7178	Latvian, Lettish: 7686	Quechua: 8185	Tamil: 8465	
Catalan: 6765	Gujarati: 7185	Lingala: 7678	Rhaeto-Romance: 8277	Tatar: 8484	

## Decoder

A decoder restores the coded audio signals on DVD's to normal. This is called decoding.

## Dolby Digital

This is a method of coding digital signals developed by Dolby Laboratories. Apart from stereo (2-channel) audio, these signals can also be multi-channel audio. A large amount of audio information can be recorded on one disc using this method.

## DTS (Digital Theater Systems)

This surround system is used in many movie theaters around the world. There is good separation between the channels, so realistic sound effects are possible.

## Dynamic range

Dynamic range is the difference between the lowest level of sound that can be heard above the noise of the equipment and the highest level of sound before distortion occurs.

## Frame still and field still

Frames are the still pictures that go together to make a moving picture. There are about 30 frames shown each second. One frame is made up of two fields. A regular television shows these fields one after the other to create frames. A still is shown when you pause a moving picture. A frame still is made up of two alternating fields, so the picture may appear blurred, but overall quality is high. A field still is not blurred, but it has only half the information of a frame still so picture quality is lower.

## I/P/B

MPEG 2, the video compression standard adopted for use with DVD-Video, codes frames using these 3 picture types.

### I: Intra coded picture

This picture has the best quality and is the best to use when adjusting the picture.

### P: Predictive coded picture

This picture is calculated based on past I or P-pictures.

### B: Bidirectionally-predictive coded picture

This picture is calculated by comparing past and future I and P-pictures so it has the lowest volume of information.

## Linear PCM (pulse code modulation)

These are uncompressed digital signals, similar to those found on CD's.

## Playback control (PBC)

If a Video CD has playback control, you can select scenes and information with menus.

# Limited Warranty (ONLY FOR U.S.A.)

Panasonic Consumer Electronics Company,  
Division of Panasonic Corporation of North America  
One Panasonic Way Secaucus, New Jersey 07094

Panasonic Puerto Rico, Inc.  
Ave. 65 de Infantería, Km. 9.5  
San Gabriel Industrial Park, Carolina, Puerto Rico 00985

## Panasonic Audio Products Limited Warranty

### Limited Warranty Coverage

If your product does not work properly because of a defect in materials or workmanship, Panasonic Consumer Electronics Company or Panasonic Puerto Rico, Inc. (collectively referred to as "the warrantor") will, for the length of the period indicated on the chart below, which starts with the date of original purchase ("warranty period"), at its option either (a) repair your product with new or refurbished parts, or (b) replace it with a new or a refurbished product. The decision to repair or replace will be made by the warrantor.

Product or Part Name	Parts	Labor
Audio Products (except items listed below)	One (1) year	One (1) year
USB Reader-Writer, Personal Computer Card Adapters (in exchange for defective item)	One (1) year	Not Applicable
Accessories: Headphones, Cartridges, Microphones, Adapters	Ninety (90) days	Ninety (90) days
Rechargeable Batteries, DVD-R/-RAM Discs (in exchange for defective item)	Ten (10) days	Not Applicable
SD Memory Cards, Rechargeable Battery Packs (in exchange for defective item)	Ninety (90) days	Not Applicable

During the "Labor" warranty period there will be no charge for labor. During the "Parts" warranty period, there will be no charge for parts. You must carry-in or mail-in your product during the warranty period. If non-rechargeable batteries are included, they are not warranted. This warranty only applies to products purchased and serviced in the United States or Puerto Rico. This warranty is extended only to the original purchaser of a new product which was not sold "as is". A purchase receipt or other proof of the original purchase date is required for warranty service.

### Carry-In or Mail-In Service

For Carry-In or Mail-In Service in the United States call 1-800-211-PANA (1-800-211-7262) or visit Panasonic web site: <http://www.panasonic.com>  
For assistance in Puerto Rico call Panasonic Puerto Rico, Inc. (787)-750-4300 or fax (787)-768-2910.

### Limited Warranty Limits And Exclusions

This warranty ONLY COVERS failures due to defects in materials or workmanship, and DOES NOT COVER normal wear and tear or cosmetic damage. The warranty ALSO DOES NOT COVER damages which occurred in shipment, or failures which are caused by products not supplied by the warrantor, or failures which result from accidents, misuse, abuse, neglect, mishandling, misapplication, alteration, faulty installation, set-up adjustments, misadjustment of consumer controls, improper maintenance, power line surge, lightning damage, modification, or commercial use (such as in a hotel, office, restaurant, or other business), rental use of the product, service by anyone other than a Factory Servicenter or other Authorized Servicer, or damage that is attributable to acts of God.

**THERE ARE NO EXPRESS WARRANTIES EXCEPT AS LISTED UNDER "LIMITED WARRANTY COVERAGE". THE WARRANTOR IS NOT LIABLE FOR INCIDENTAL OR CONSEQUENTIAL DAMAGES RESULTING FROM THE USE OF THIS PRODUCT, OR ARISING OUT OF ANY BREACH OF THIS WARRANTY.** (As examples, this excludes damages for lost time, travel to and from the servicer, loss of media or images, data or other memory content. The items listed are not exclusive, but are for illustration only.) **ALL EXPRESS AND IMPLIED WARRANTIES, INCLUDING THE WARRANTY OF MERCHANTABILITY, ARE LIMITED TO THE PERIOD OF THE LIMITED WARRANTY.**

Some states do not allow the exclusion or limitation of incidental or consequential damages, or limitations on how long an implied warranty lasts, so the exclusions may not apply to you. This warranty gives you specific legal rights and you may also have other rights which vary from state to state. If a problem with this product develops during or after the warranty period, you may contact your dealer or Servicenter. If the problem is not handled to your satisfaction, then write to the warrantor's Consumer Affairs Department at the addresses listed for the warrantor.

**PARTS AND SERVICE WHICH ARE NOT COVERED BY THIS LIMITED WARRANTY ARE YOUR RESPONSIBILITY.**

## Customer Services Directory

Obtain Product Information and Operating Assistance; locate your nearest Dealer or Servicenter; purchase Parts and Accessories; or make Customer Service and Literature requests by visiting our Web Site at:

<http://www.panasonic.com/consumersupport>

or, contact us via the web at:

<http://www.panasonic.com/contactinfo>

You may also contact us directly at:

1-800-211-PANA (7262),

Monday-Friday 9 am-9 pm; Saturday-Sunday 10 am-7 pm, EST.

For hearing or speech impaired TTY users, TTY : 1-877-833-8855

## Accessory Purchases

Purchase Parts, Accessories and Instruction Books online for all Panasonic Products by visiting our Web Site at:

<http://www.pasc.panasonic.com>

or, send your request by E-mail to:

[npcparts@us.panasonic.com](mailto:npcparts@us.panasonic.com)

You may also contact us directly at:

1-800-332-5368 (Phone) 1-800-237-9080 (Fax Only) (Monday – Friday 9 am to 8 pm, EST.)

Panasonic Services Company

20421 84th Avenue South, Kent, WA 98032

(We Accept Visa, MasterCard, Discover Card, American Express, and Personal Checks)

For hearing or speech impaired TTY users, TTY : 1-866-605-1277

## Service in Puerto Rico

Panasonic Puerto Rico, Inc.

Ave. 65 de Infantería, Km. 9.5, San Gabriel Industrial Park, Carolina, Puerto Rico 00985

Phone (787)750-4300, Fax (787)768-2910

Limited Warranty (ONLY FOR U.S.A.)



## Listening caution



Selecting fine audio equipment such as the unit you've just purchased is only the start of your musical enjoyment. Now it's time to consider how you can maximize the fun and excitement your equipment offers. This manufacturer and the Electronic Industries Association's Consumer Electronics Group want you to get the most out of your equipment by playing it at a safe level. One that lets the sound come through loud and clear without annoying blaring or distortion—and, most importantly, without affecting your sensitive hearing.

We recommend that you avoid prolonged exposure to excessive noise.

Sound can be deceiving. Over time your hearing "comfort level" adapts to higher volumes of sound. So what sounds "normal" can actually be loud and harmful to your hearing.

Guard against this by setting your equipment at a safe level BEFORE your hearing adapts.

To establish a safe level:

- Start your volume control at a low setting.
- Slowly increase the sound until you can hear it comfortably and clearly, and without distortion.

Once you have established a comfortable sound level:

- Set the dial and leave it there.

Taking a minute to do this now will help to prevent hearing damage or loss in the future. After all, we want you listening for a lifetime.

### Television code list

Panasonic:	01, 02, 26	Philco:	06, 07
Sony:	04	Philips:	06
Fisher:	14	Pioneer:	02, 10, 19
G-E:	02, 03, 07, 09	Quasar:	02
Gold Star:	07, 15	RCA:	03, 07, 09, 13, 23, 24, 25
Hitachi:	05, 07	Sanyo:	14
JVC:	12	Sharp:	08, 21
LXI:	03, 06, 07, 10, 14, 15	Sylvania:	06, 07, 15
Magnavox:	06, 07, 11, 15, 22	Symphonic:	17
Mitsubishi:	07, 15, 16, 21	Toshiba:	10, 21
NEC:	07, 15	Zenith:	18, 20

### Video cassette recorder code list

Panasonic:	01, 02, 09, 33	NEC:	19, 25, 31, 38
Sony:	05, 06, 07, 35, 36, 37	Philco:	02, 09, 12, 30
Fisher:	13, 14, 15, 18, 34	Philips:	02, 09, 12
Funai:	08, 30	Pioneer:	09
G-E:	02, 03, 11	Quasar:	01, 02, 09, 33
Gold Star:	27	RCA:	02, 03, 04, 09, 10, 11, 12, 23, 24, 26
Hitachi:	09, 10, 11	Sanyo:	14, 18, 34
JVC:	19, 25, 31, 38, 39, 40	Sharp:	16, 17
LXI:	10, 13, 14, 15, 18, 27, 30	Shintom:	32
Magnavox:	02, 09, 12	Sylvania:	02, 09, 12, 30
Mitsubishi:	21, 22, 28, 29	Symphonic:	30
		Toshiba:	23, 24
		Zenith:	20

## Accessories



Please check and identify the supplied accessories. Use numbers indicated in parentheses when asking for replacement parts. (Product numbers correct as of December 2004. These may be subject to change.)

**Only for U.S.A.:** To order accessories, refer to "Accessory Purchases" on page 31.

**For other areas:** To order accessories, call the dealer from whom you made your purchase.

- 1 Remote control**  
(EUR7722XG0)



- 2 Remote control batteries**



- 1 Video cable**  
(K2KA2BA00001)



- 1 AM loop antenna**  
(N1DAAAA00001)



- 1 FM indoor antenna**  
(RSA0007-L)



- 3 Speaker cables**  
1 × short cable  
(REEX0449B)



- 2 × long cables  
(REEX0449E)



- 2 Sheets of speaker-cable stickers**



- 1 Sheet of rubber pads**  
(RKAX0025-K)



- 2 Pipes (A)**  
(RYBX0095-S)



- 2 Pipes (B)**  
(RMAX0076-S)



- 2 Bases**  
(RYQX0198-S)



- 4 Washer screws**  
(XTW5+10LFJ)



- 4 Small screws**  
(XTB3+8JFJ)



- 4 Bracket screws**  
(XSN5+10FJ)



- 2 Brackets**  
(RYQX0205-S)



- 1 AC power supply cord**  
(K2CB2CB00018)

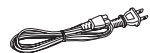

#### Note

The included AC power supply cord is for use with this unit only. Do not use it with other equipment.

**Panasonic Consumer Electronics Company, Division of Panasonic Corporation of North America**  
One Panasonic Way Secaucus,  
New Jersey 07094  
<http://www.panasonic.com>

**Panasonic Puerto Rico, Inc.**  
Ave. 65 de Infantería, Km. 9.5  
San Gabriel Industrial Park, Carolina,  
Puerto Rico 00985

**Panasonic Canada Inc.**  
5770 Ambler Drive  
Mississauga, Ontario  
L4W 2T3  
[www.panasonic.ca](http://www.panasonic.ca)

En